

SONY[®]

Multi Channel AV Receiver

Operating Instructions

For the customers in the USA

Owner's Record

The model and serial numbers are located on the rear of the receiver. Record the serial number in the space provided below. Refer to these numbers whenever you call upon your Sony dealer regarding this product.

Model No. STR-DN1080

Serial No. _____

WARNING

To reduce the risk of fire or electric shock, do not expose this apparatus to rain or moisture.

To reduce the risk of fire, do not cover the ventilation opening of the appliance with newspapers, tablecloths, curtains, etc. Do not expose the appliance to naked flame sources (for example, lighted candles).

To reduce the risk of fire or electric shock, do not expose this appliance to dripping or splashing, and do not place objects filled with liquids, such as vases, on the appliance.

Do not install the appliance in a confined space, such as a bookcase or built-in cabinet.

As the main plug is used to disconnect the unit from the mains, connect the unit to an easily accessible AC outlet. Should you notice an abnormality in the unit, disconnect the main plug from the AC outlet immediately.

The unit is not disconnected from the mains as long as it is connected to the AC outlet, even if the unit itself has been turned off.

CAUTION

Risk of explosion if the battery is replaced by an incorrect type.

Do not expose batteries or appliances with battery-installed to excessive heat, such as sunshine and fire.



This symbol is intended to alert the user to the presence of the Hot Surface that may be hot if it is touched during the normal operation.

FOR UNITED STATES CUSTOMERS. NOT APPLICABLE IN CANADA, INCLUDING IN THE PROVINCE OF QUEBEC.

POUR LES CONSOMMATEURS AUX ÉTATS-UNIS. NON APPLICABLE AU CANADA, Y COMPRIS LA PROVINCE DE QUÉBEC.

For the customers in the USA



This symbol is intended to alert the user to the presence of uninsulated "dangerous voltage" within the product's enclosure that may be of sufficient magnitude to constitute a risk of electric shock to persons.



This symbol is intended to alert the user to the presence of important operating and maintenance (servicing) instructions in the literature accompanying the appliance.

Important Safety Instructions

- 1) Read these instructions.
- 2) Keep these instructions.
- 3) Heed all warnings.
- 4) Follow all instructions.
- 5) Do not use this apparatus near water.
- 6) Clean only with dry cloth.
- 7) Do not block any ventilation openings. Install in accordance with the manufacturer's instructions.
- 8) Do not install near any heat sources such as radiators, heat registers, stoves, or other apparatus (including amplifiers) that produce heat.
- 9) Do not defeat the safety purpose of the polarized or grounding-type plug. A polarized plug has two blades with one wider than the other. A grounding type plug has two blades and a third grounding prong. The wide blade or the third prong are provided for your safety. If the provided plug does not fit into your outlet, consult an electrician for replacement of the obsolete outlet.
- 10) Protect the power cord from being walked on or pinched particularly at plugs, convenience receptacles, and the point where they exit from the apparatus.
- 11) Only use attachments/accessories specified by the manufacturer.

- 12) Use only with the cart, stand, tripod, bracket, or table specified by the manufacturer, or sold with the apparatus. When a cart is used, use caution when moving the cart/apparatus combination to avoid injury from tip-over.



- 13) Unplug this apparatus during lightning storms or when unused for long periods of time.
- 14) Refer all servicing to qualified service personnel. Servicing is required when the apparatus has been damaged in any way, such as power-supply cord or plug is damaged, liquid has been spilled or objects have fallen into the apparatus, the apparatus has been exposed to rain or moisture, does not operate normally, or has been dropped.

NOTE:

This equipment has been tested and found to comply with the limits for a Class B digital device, pursuant to Part 15 of the FCC Rules. These limits are designed to provide reasonable protection against harmful interference in a residential installation. This equipment generates, uses and can radiate radio frequency energy and, if not installed and used in accordance with the instructions, may cause harmful interference to radio communications. However, there is no guarantee that interference will not occur in a particular installation. If this equipment does cause harmful interference to radio or television reception, which can be determined by turning the equipment off and on, the user is encouraged to try to correct the interference by one or more of the following measures:

- Reorient or relocate the receiving antenna.
- Increase the separation between the equipment and receiver.
- Connect the equipment into an outlet on a circuit different from that to which the receiver is connected.
- Consult the dealer or an experienced radio/TV technician for help.

CAUTION

You are cautioned that any changes or modifications not expressly approved in this manual could void your authority to operate this equipment.

Properly shielded and grounded cables and connectors must be used for connection to host computers and/or peripherals in order to meet FCC emission limits.

To reduce the risk of electric shock, the speaker cable should be connected to the apparatus and the speakers in accordance with the following instructions.

- 1) Disconnect the AC power cord from the MAINS.
- 2) Strip 10 to 15 mm of the wire insulation of the speaker cable.
- 3) Connect the speaker cable to the apparatus and the speakers carefully so as not to touch the core of speaker cable by hand. Also disconnect the AC power cord from the MAINS before disconnecting the speaker cable from the apparatus and the speakers.

This equipment must not be co-located or operated in conjunction with any other antenna or transmitter.

This equipment complies with FCC radiation exposure limits set forth for an uncontrolled environment and meets the FCC radio frequency (RF) Exposure Guidelines. This equipment should be installed and operated keeping the radiator at least 20 cm or more away from person's body (excluding extremities: hands, wrists, feet and ankles).

5.47 GHz – 5.725 GHz band is restricted to indoor operations only.

Compliance with FCC requirement 15.407(c) Data transmission is always initiated by software, which is the passed down through the MAC, through the digital and analog baseband, and finally to the RF chip. Several special packets are initiated by the MAC. These are the only ways the digital baseband portion will turn on the RF transmitter, which it then turns off at the end of the packet.

Therefore, the transmitter will be on only while one of the aforementioned packets is being transmitted. In other words, this device automatically discontinues transmission in case of either absence of information to transmit or operational failure.

Frequency Tolerance: ± 20 ppm

For the customers in Canada

Properly shielded and grounded cables and connectors must be used for connection to host computers and/or peripherals.

This device complies with Industry Canada's licence-exempt RSSs. Operation is subject to the following two conditions:

- (1) This device may not cause interference; and
- (2) This device must accept any interference, including interference that may cause undesired operation of the device.

This equipment complies with IC radiation exposure limits set forth for an uncontrolled environment and meets RSS-102 of the IC radio frequency (RF) Exposure rules. This equipment should be installed and operated keeping the radiator at least 20 cm or more away from person's body (excluding extremities: hands, wrists, feet and ankles).

5,150 MHz – 5,250 MHz band is restricted to indoor operations only.

High-power radars are allocated as primary users (i.e. priority users) of the bands 5,250 MHz – 5,350 MHz and 5,650 MHz – 5,850 MHz and that these radars could cause interference and/or damage to LE-LAN devices.

For the customers in Australia and New Zealand

This equipment should be installed and operated with at least 20 cm and more between the radiator and person's body (excluding extremities: hands, wrists, feet and ankles).

For the customers in Australia



Disposal of Old Electrical & Electronic Equipment (Applicable in the European Union and other European countries with separate collection systems)

For the customers in Europe



Disposal of waste batteries and electrical and electronic equipment (applicable in the European Union and other European countries with separate collection systems)

This symbol on the product, the battery or on the packaging indicates that the product and the battery shall not be treated as household waste. On certain batteries this symbol might be used in combination with a chemical symbol. The chemical symbols for mercury (Hg) or lead (Pb) are added if the battery contains more than 0.0005% mercury or 0.004% lead. By ensuring these products and batteries are disposed of correctly, you will help prevent potentially negative consequences for the environment and human health which could otherwise be caused by inappropriate waste handling. The recycling of the materials will help to conserve natural resources.

In case of products that for safety, performance or data integrity reasons require a permanent connection with an incorporated battery, this battery should be replaced by qualified service staff only. To ensure that the battery and the electrical and electronic equipment will be treated properly, hand over these products at end-of-life to the applicable collection point for the recycling of electrical and electronic equipment. For all other batteries, please view the section on how to remove the battery from the product safely. Hand the battery over to the applicable collection point for the recycling of waste batteries. For more detailed information about recycling of this product or battery, please contact your local Civic Office, your household waste disposal service or the shop where you purchased the product or battery.

Notice for customers: the following information is only applicable to equipment sold in countries applying EU directives

This product has been manufactured by or on behalf of Sony Corporation, 1-7-1 Konan Minato-ku Tokyo, 108-0075 Japan. Inquiries related to product compliance based on European Union legislation shall be addressed to the authorized representative, Sony Belgium, bijkantoor van Sony Europe Limited, Davincilaan 7-D1, 1935 Zaventem, Belgium. For any service or guarantee matters, please refer to the addresses provided in the separate service or guarantee documents.

Hereby, Sony Corporation declares that this equipment is in compliance with Directive 2014/53/EU.

The full text of the EU declaration of conformity is available at the following internet address:
<http://www.compliance.sony.de/>



For this radio equipment, the following restrictions on putting into service or of requirements for authorization of use apply in BE, BG, CZ, DK, DE, EE, IE, EL, ES, FR, HR, IT, CY, LV, LT, LU, HU, MT, NL, AT, PL, PT, RO, SI, SK, FI, SE, UK, IS, LI, NO, CH, AL, BA, MK, MD, RS, ME, XK, TR:

5,150 MHz – 5,350 MHz band is restricted to indoor operations only.

This Multi Channel AV Receiver is intended for sound and video playback from connected devices, music streaming from an NFC-compatible smartphone or a BLUETOOTH device, and FM tuner. This system also supports network streaming.

This equipment has been tested and found to comply with the limits set out in the EMC regulation using a connection cable shorter than 3 meters.

This radio equipment is intended to be used with the approved version(s) of software that are indicated in the EU Declaration of Conformity. The software loaded on this radio equipment is verified to comply with the essential requirements of the Directive 2014/53/EU.

Software version: M __.R. ____

You can display the software version information. (System Information)

- Select [Setup] - [System Settings] from the home menu.
- Select [System Information].

Excessive sound pressure from earphones and headphones can cause hearing loss.

Manuals provided for this product

The following manuals are provided for this product.
The information included in each manual is as shown below:



Startup Guide



Operating Instructions (this booklet)



Help Guide (online)

Preparation

Installation
Connections
Initial Setup

Basic operations

Listening/Watching

Advanced operations

Listening/Watching

Advanced operations

BLUETOOTH features
Network features
Multi-zone features
Other features
Adjusting Settings

Troubleshooting

Precautions / Specifications

To read the Help Guide, go to the following website:



For the customers in Europe
http://rd1.sony.net/help/ha/strdn108/h_eu/



For the customers in other areas
http://rd1.sony.net/help/ha/strdn108/h_zz/



About These Operating Instructions

- These Operating Instructions mainly describe the procedures for using the remote control. You can also use the controls on the receiver if they have the same or similar names as those on the remote control.
- Some illustrations are presented as conceptual drawings, and may be different from the actual products.
- These Operating Instructions cover models for the United States, Canada, Oceanian and European countries. Only the USA and Canadian models are equipped with the SPEAKERS ZONE 2 terminals on the rear of the receiver. The USA and Canadian models are used for illustrative purposes in these Operating Instructions.
- The items displayed on the TV screen may vary depending on the area.
- The text enclosed in bracket ([--]) appears on the TV screen, and the text enclosed in double quotation mark ("--") appears on the display panel.

Table of Contents

Manuals provided for this product	6
About These Operating Instructions	7
Main features of the receiver	8
Supplied Accessories	11
Parts and Controls	12

Preparation

Installing Speakers	18
Connecting Speakers	20
Connecting a TV	29
Connecting Audio-Visual Devices	33
Connecting to a network	38
Connecting the Antenna (aerial)	39
Connecting the AC Power Cord (mains lead)	39
Setting up the Receiver using the Easy Setup	40

Listening/Watching

Enjoying Sound and Video	42
Enjoying Sound Effects	46
Network functions	50
Listening with BLUETOOTH headphones/ speakers	51

Additional Information

Saving power	53
Updating the Software	53
Troubleshooting	54
Precautions	58
Specifications	61
END USER LICENSE AGREEMENT	66

Main features of the receiver

Compatible with a variety of connections and high-quality audio/video formats

Compatible with wired/wireless network, BLUETOOTH, and USB connections

- Connect a Walkman, iPod/iPhone (AirPlay), computer, NAS, or USB device to the receiver to play content on those devices or transmit music to BLUETOOTH headphones/speakers.
- Music services such as Spotify and Chromecast built-in are supported.
For details, see the Help Guide.

Compatible with the latest object-based audio formats

Dolby Atmos (page 24) and DTS:X are supported.

Compatible with high-definition playback of High- Resolution Audio

- During network audio playback or content playback on a USB device, the receiver supports High- Resolution Audio content at up to 5.6 MHz in the DSD format and at up to 192 kHz/24 bits in the WAV, FLAC, and AIFF formats.
- Native playback of DSD files is also supported.

Compatible with high-definition 4K video formats*

- The receiver supports 4K HDR and HDCP 2.2, letting you enjoy high-definition video images (page 33).

* You need to change the setting of [HDMI Signal Format] depending on the input video signal.

Functions for an optimum surround environment

Automatically calibrating your viewing and listening environment to create an ideal surround space using Auto Calibration (D.C.A.C. EX*)

- D.C.A.C. EX measures and calibrates the distance, angle, level, and frequency characteristics of the speakers using the supplied stereo calibration microphone (page 40).
- The optimum sound is then produced by simulating ideal speaker positions and angles (Speaker Relocation**).

Calibration functions for sound fields corresponding to various speaker installation conditions

- **Phantom Surround Back****: Allows you to enjoy a surround-sound effect acoustically equivalent to that of a 7-channel speaker system, using only a 5-channel speaker system, and when using a 5.1.2-channel speaker system, it allows you to enjoy a surround-sound effect acoustically equivalent to that of a 7.1.2-channel speaker system.
- **Front Surround**: Allows you to enjoy virtual surround sound with only two front speakers (page 28).

- **In-Ceiling Speaker Mode****: Reproduces more natural sound by lowering the position of audio output from speakers installed in the ceiling.
 - **Center Speaker Lift Up****: Reproduces natural sound that feels more authentic by lifting the sound from the center speaker up to the height of the screen.
- * Digital Cinema Auto Calibration EX
 ** For details, see the Help Guide.

Audio technologies for high-definition music playback

Sound fields selectable by preference

You can select from a variety of sound fields according to speaker connections or input sources (2ch Stereo, Direct, Auto Format Decoding, etc.) (page 46).

Upscaling of existing sound sources into higher resolutions with the same quantity of information as High-Resolution Audio using DSEE HX (Digital Sound Enhancement Engine HX)*

The receiver restores signals in the micro region of compressed sound sources by up-sampling the sampling frequency and expanding the bit depth to the equivalent of a maximum of 192 kHz/24 bits, letting you enjoy CDs and lossy compressed sound sources such as MP3 files in expressive sound quality closer to the original.

High-definition BLUETOOTH music playback (LDAC)*

LDAC allows approximately three times more data to be transmitted than with the previous BLUETOOTH A2DP-SBC (328 kbps, 44.1 kHz). The receiver supports wireless playback (transmission/reception) of high-quality sound when speakers, headphones, a Walkman, or a smartphone that supports LDAC are connected to the receiver via a BLUETOOTH connection.

Reproduction of authentic impact and realistic sense of immersion in movies (Sound Optimizer)*

Sound Optimizer calibrates the disparity in acoustic frequency characteristic between movie production and playback caused by different volume levels, reproducing the impact and immersive surround effect that the movie's sound engineers intended even when it is played back at low volume levels in a home.

* For details, see the Help Guide.

Other useful functions

Compatible with "SongPal" and "SongPal Link"*

SongPal is a dedicated app for operating SongPal compatible audio devices manufactured by Sony from a smartphone or tablet device. It lets you operate the receiver from the smartphone or tablet device and use the SongPal Link function.

Equipped with an ARC-compatible HDMI jack

TV sound can be output from the receiver using only one HDMI cable (page 31).

Supports bi-amping of front speakers

You can enhance the sound quality of the front speakers by connecting different amplifiers to the tweeter and woofer using a bi-amplifier connection (page 26).

Support for music and video playback in different rooms

- The Wireless Multi-Room function** lets you listen to the same music in different rooms.
- The multi-zone features let you output audio and video signals to another room.

* For details, see the Help Guide.

** You can enjoy the sound of the device that is connected to the receiver. The sound is delayed behind the picture.

Supplied Accessories

- Remote control (1)
- R03 (size AAA) batteries (2)
- FM wire antenna (aerial) (1)

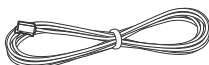

- Calibration microphone (1)

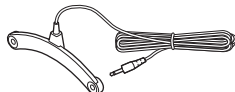

Inserting batteries into the remote control

Insert two R03 (size AAA) batteries (supplied) in the remote control. Make sure that the + and - ends are in the correct position when installing batteries.

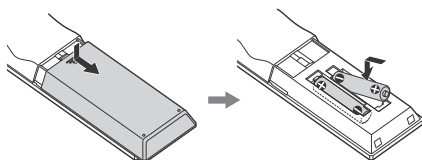

Note

- Do not leave the remote control in an extremely hot or humid place.
- Do not use a new battery with old ones.
- Do not mix manganese batteries and other kinds of batteries.
- Do not expose the remote control sensor to direct sunlight or lights. Doing so may cause a malfunction.
- If you do not intend to use the remote control for an extended period of time, remove the batteries to avoid possible damage from battery leakage and corrosion.
- When the receiver no longer responds to the remote control, replace both of the batteries with new ones.

Parts and Controls

Receiver

Front panel

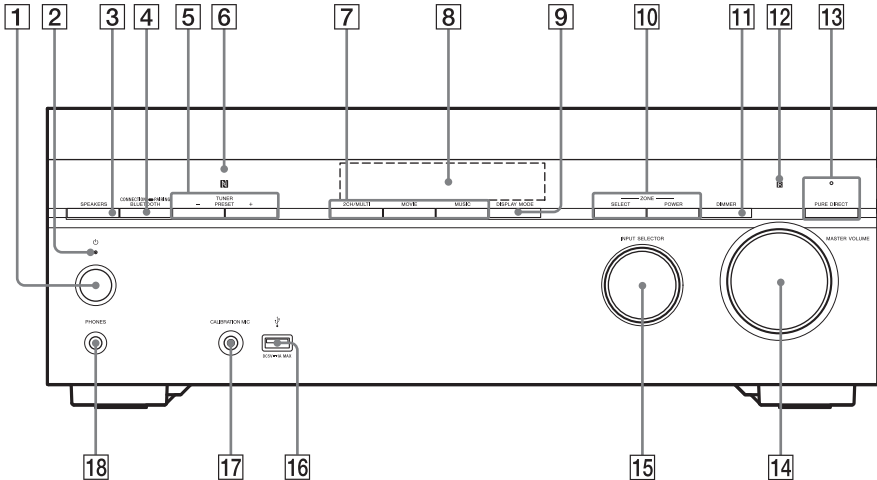

- 1 (power) (page 39)
- 2 **Power indicator**
- 3 **SPEAKERS** (page 41)
- 4 **CONNECTION PAIRING BLUETOOTH**
Operates the BLUETOOTH function.
- 5 **TUNER PRESET +/-**
Selects preset stations or channels.
- 6 **NFC sensor**
- 7 **2CH/MULTI, MOVIE, MUSIC** (page 46)
- 8 **Display panel** (page 13)
- 9 **DISPLAY MODE**
Switches information on the display panel.
- 10 **ZONE SELECT, ZONE POWER** (page 43, 44)
- 11 **DIMMER**
Adjusts the brightness of the display panel.
- 12 **Remote control sensor**
Receives signals from remote control.
- 13 **PURE DIRECT**
The indicator above the button lights up when the Pure Direct function is activated.
- 14 **MASTER VOLUME** (page 42)
- 15 **INPUT SELECTOR** (page 42)
- 16 **(USB) port**
Connect a USB device here.
- 17 **CALIBRATION MIC jack** (page 41)

- 18 **PHONES jack**
Connect headphones here.

Power indicator

- Green: The receiver is turned on.
- Amber: The receiver is in standby mode, and you have set one of the following:
 - [Control for HDMI], [Remote Start]*, [Bluetooth Standby], or [Network Standby]* is set to [On].
 - [Standby Through] is set to [On] or [Auto].
 - [Zone2 Power] or [HDMI Zone Power] is set to [On].
- The indicator goes off: The receiver is in standby mode and all of the following settings are set to [Off]:
 - [Control for HDMI]
 - [Standby Through]
 - [Remote Start]*
 - [Bluetooth Standby]
 - [Network Standby]*
 - [Zone2 Power] and [HDMI Zone Power]

* For USA, Canadian and Oceanian models only.

Indicators on the display panel

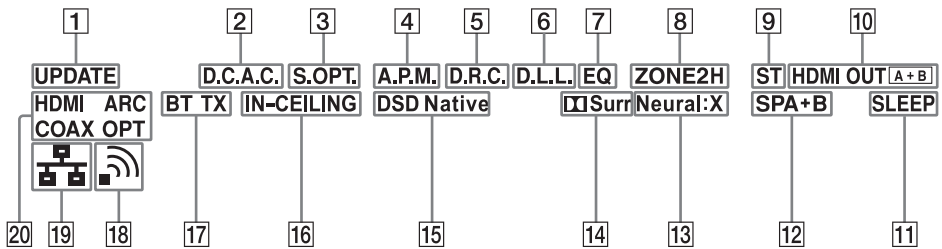

- 1 UPDATE**
Lights up when new software is available.
- 2 D.C.A.C.**
Lights up when the measurement results of the Auto Calibration (D.C.A.C. EX) function are applied.
- 3 S.OPT.**
Lights up when the Sound Optimizer function is activated.
- 4 A.P.M.**
Lights up when the A.P.M. (Automatic Phase Matching) function is activated. You can only set the A.P.M. function in the D.C.A.C. function.
- 5 D.R.C.**
Lights up when dynamic range compression is activated.
- 6 D.L.L.**
Lights up when the D.L.L. (Digital Legato Linear) function is activated.
- 7 EQ**
Lights up when the equalizer is activated.
- 8 ZONE2, ZONE H**
"ZONE2" lights up when the power for Zone 2 is on.
"ZONE H" lights up when the power for HDMI zone is on.
- 9 ST**
Lights up when the receiver tunes to a FM stereo broadcast.
- 10 HDMI OUT A + B**
Indicates the HDMI OUT jacks that currently output the audio/video signals.
- 11 SLEEP**
Lights up when the sleep timer is activated.
- 12 Speaker system indicator (page 41)**
- 13 Neural:X**
Lights up when DTS Neural:X decoding is activated.
- 14 Surr**
Lights up when Dolby Surround decoding is activated.
- 15 DSD Native**
Lights up when DSD native playback function is activated.
- 16 IN-CEILING**
Lights up when the In-Ceiling Speaker Mode is activated.
- 17 BLUETOOTH indicator**
"BT" lights up when a BLUETOOTH device is connected. Flashes while connecting.
"BT TX" lights up when an Audio-Visual device connected to the receiver sends audio to the BLUETOOTH headphones/speakers.
- 18 Wireless LAN signal strength indicator**
Show the strength of the wireless LAN signal.
 - No signal
 - Weak
 - Moderate
 - Strong
- 19 Wired LAN indicator**
Lights up when a LAN cable is connected.
- 20 Input indicator**
Lights up to indicate the current input.
 - HDMI**
Digital signals are input through the selected HDMI jack.
 - ARC**
TV input is selected and Audio Return Channel (ARC) signals are detected.
 - COAX**
Digital signals are input through the COAXIAL jack.
 - OPT**
Digital signals are input through the OPTICAL jack.

Note

These indicators may not light up depending on the speaker pattern setting.

Rear panel

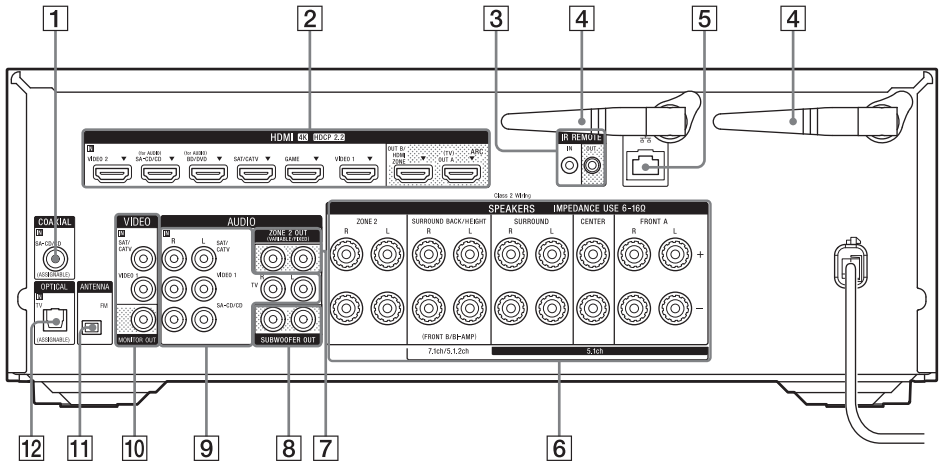

1 COAXIAL IN jack

2 HDMI IN/OUT jacks*

3 IR REMOTE IN/OUT jacks

- You can control the receiver from a distance by connecting an IR repeater (not supplied) to the IR REMOTE IN jack.
- You can start or stop playback of devices such as a CD player connected to the receiver by connecting an IR blaster (not supplied) to the IR REMOTE OUT jack.

4 Wireless LAN antenna

5 LAN port

6 SPEAKERS terminals

Only the USA and Canadian models are equipped with the SPEAKERS ZONE 2 terminals. The USA and Canadian models are used for illustrative purposes in these Operating Instructions.

7 ZONE 2 OUT jacks

8 SUBWOOFER OUT jacks

9 AUDIO IN jacks

10 VIDEO IN/MONITOR OUT jacks

11 FM ANTENNA terminal

12 OPTICAL IN jack

* All of the HDMI IN/OUT jacks on the receiver support HDCP 2.2. HDCP 2.2 is newly enhanced copyright protection technology that is used to protect content such as 4K movies.

About input/output of video signals

The digital video signals input to the HDMI IN jacks of this receiver are output from HDMI OUT A (TV) or HDMI OUT B/HDMI ZONE jacks only. The analog video signals input from VIDEO IN jacks are output from the MONITOR OUT jack only.

Use the following illustration as reference when you connect the receiver, AV device, and TV.

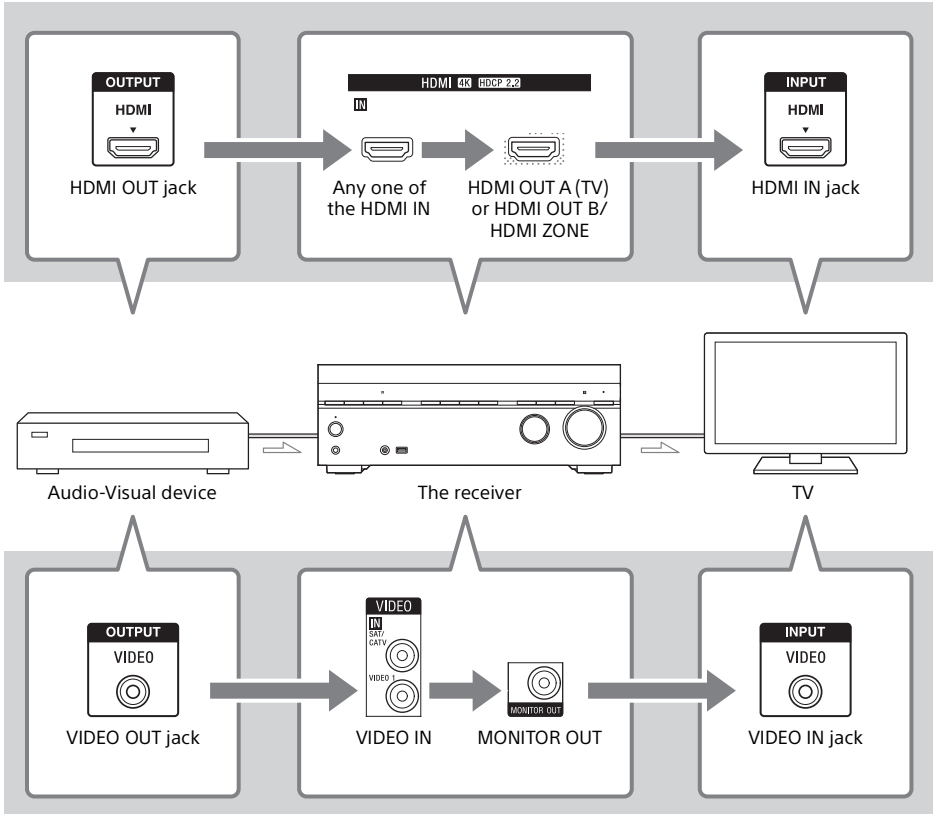

Note

When you connect the TV to the MONITOR OUT jack, the home menu of this receiver is not displayed on the TV screen. To operate this receiver using the menu on the TV screen, connect the TV to the HDMI OUT A (TV) or HDMI OUT B/HDMI ZONE jacks.

Remote control

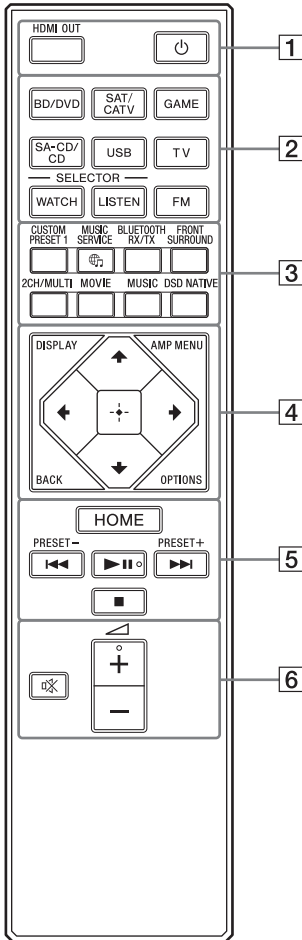

1 (power)

Turns the receiver on or sets it to the standby mode.

HDMI OUT

Switches the output for two TVs connected to the HDMI OUT A (TV) and HDMI OUT B/HDMI ZONE jacks.

When [HDMI Out B Mode] is set to [Main] in the [HDMI Settings] menu, output is toggled between "HDMI A", "HDMI B", "HDMI A+B" and "HDMI OFF" each time the button is pressed.

When [HDMI Out B Mode] is set to [Zone], output is toggled between "HDMI A" and "HDMI OFF" each time the button is pressed.

Select "HDMI OFF" to turn off the output for the HDMI OUT A (TV) and HDMI OUT B/HDMI ZONE jacks.

2 **Input buttons** **BD/DVD, SAT/CATV, GAME, SA-CD/CD, USB, TV, FM**

Selects the input channel connected to the device you want to use. When you press any of the input buttons, the receiver turns on.

WATCH, LISTEN

Allows you to display the Watch or Listen screen directly without the need to select it on the home menu.

Press WATCH to display the Watch screen or LISTEN to display the Listen screen. Then press either WATCH or LISTEN to select the input you want to view.

3 **CUSTOM PRESET 1**

Saves and recalls various settings for the receiver. Press to select the custom preset setting. Press and hold to save the current settings to a preset.

MUSIC SERVICE

If you have listened to music streamed from Spotify^{1), 2)} on this receiver, press MUSIC SERVICE to play the same music from exactly the point it was left off. For details on operation, visit the Help Guide.

BLUETOOTH RX/TX

Switches the [Bluetooth Mode] to [Receiver] or [Transmitter].

In [Receiver] mode, the receiver receives and outputs audio from the player.

In [Transmitter] mode, the receiver sends audio to BLUETOOTH headphones/speakers.

FRONT SURROUND, 2CH/MULTI, MOVIE, MUSIC

Selects a sound field.

DSD NATIVE

Activates the DSD Native function.

4 **DISPLAY**

Displays information on the TV screen.

AMP MENU

Displays the menu on the display panel to operate the receiver.

BACK

Returns to the previous menu or exits a menu or on-screen guide that is displayed on the TV screen.

OPTIONS

Displays the options menus.

(The menu is not displayed for the TV input.)

(enter), ///

Press , , , to select the menu items. Then, press to enter the selection.

5 HOME

Displays the home menu on the TV screen.

**◀◀/▶▶ (previous/next),
▶|| (play/pause)³⁾, ■ (stop)**

Skip, play, pause, stop operation.

PRESET +/-

Selects preset stations or channels.

6 (volume) +³⁾/-

Adjusts the volume level of all speakers at the same time.

 (muting)

Turns off the sound temporarily. Press the button again to restore the sound.

¹⁾ Available services may vary depending on your location.

²⁾ Spotify playback using the receiver is limited to Spotify Premium account holders.

³⁾ The **▶||** and ** +** buttons have tactile dots. Use the tactile dots as reference when operating the receiver.

Note

- The above explanation is intended to serve as examples.
- Depending on the model of your connected device, some functions explained in this section may not work with the supplied remote control.

Preparation

Installing Speakers

You can connect up to 7 speakers and 2 subwoofers to this AV receiver. Place the speakers and subwoofers according to the speaker system of your preference.

Location of each speaker

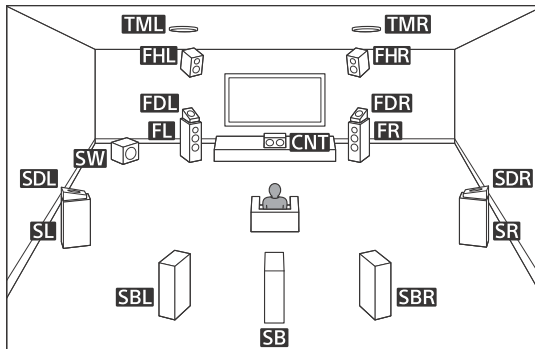

Note

- When you connect only one surround back speaker (SB), place the surround back speaker directly behind the listening position.
- As the subwoofer (SW) does not emit highly directional signals, you can place it wherever you want.

Names and functions of speakers

Abbreviations used in illustrations	Speaker name	Functions
FL	Front left speaker	Produces sounds from front left/right channels.
FR	Front right speaker	
CNT	Center speaker	Produces vocal sounds from center channel.
SL	Surround left speaker	Produces sounds from surround left/right channels.
SR	Surround right speaker	
SBL	Surround back left speaker	Produces sounds from surround back left/right channels.
SBR	Surround back right speaker	
SB	Surround back speaker	Produces sounds from surround back channel.
SW	Subwoofer	Produces LFE (low frequency effect) channel sounds and reinforces bass parts of other channels.
TML	Top middle left speaker	Produces sounds from top middle left/right channels.
TMR	Top middle right speaker	

Abbreviations used in illustrations	Speaker name	Functions
FDL	Front Dolby Atmos enabled left speaker	Produces sounds from the top middle left/right channels and reflects these sounds off the ceiling. Enables playing back sounds of Dolby Atmos 3D movies without the need to install ceiling speakers.
FDR	Front Dolby Atmos enabled right speaker	
SDL	Surround Dolby Atmos enabled left speaker	Produces sounds from the top middle left/right channels and reflects these sounds off the ceiling. Enables playing back sounds of Dolby Atmos 3D movies without the need to install ceiling speakers.
SDR	Surround Dolby Atmos enabled right speaker	
FHL	Front high left speaker	Produces vertical sound effects from front height left/right channels.
FHR	Front high right speaker	

Speaker configuration and speaker pattern settings

Select the speaker pattern according to the speaker configuration which you are using. The table below shows examples of speaker configurations and speaker pattern settings. For speaker placement and connection diagrams for each speaker configuration example, see “Examples of speaker connections” (page 21).

Speaker configuration in each zone		[Surround Back Speaker Assign]*	[Speaker Pattern] setting	For connection, see page
Main zone	Zone 2			
5.1-channel	Not used	—	[5.1]	21
7.1-channel using surround back speakers	Not used	—	[7.1]	22
5.1.2-channel using top middle speakers	Not used	—	[5.1.2 (TM)]	23
5.1.2-channel using Dolby Atmos enabled speakers	Not used	—	[5.1.2 (FD)]	24
5.1-channel with Zone 2 speakers	2-channel	[Zone2]	[5.1]	25
5.1-channel with Bi-Amplifier connection	Not used	[BI-AMP]	[5.1]	26
2.1-channel (for enjoying Front Surround)	Not used	—	[2.1]	28

* You can only set [Surround Back Speaker Assign] if the speaker pattern is set to a setting that does not have surround back and height speakers.

Tip

The receiver allows you to enjoy a surround-sound effect acoustically equivalent to that of up to a 7.1.2-channel speaker system when you select [Type A] or [Type B] for [SpeakerRelocation/PhantomSurroundBack] in the [Speaker Settings] menu.

When setting [SpeakerRelocation/PhantomSurroundBack], perform Auto Calibration beforehand (page 40).

Connecting Speakers

This receiver allows you to connect up to 7.1-channel system.

The speaker layout diagram is a guide for the ideal speaker placement. You do not need to adjust your speaker placement exactly the same as the diagram.

Note

- Before connecting cables, be sure to disconnect the AC power cord (mains lead).
- Before connecting the AC power cord (mains lead), make sure that metallic wires of the speaker cables are not touching each other between the SPEAKERS terminals.
- When you connect a subwoofer with an auto standby function, turn off the function when watching movies. If the auto standby function is set to on, it turns to standby mode automatically based on the level of the input signal to the subwoofer, and the sound may not be output.
- If you have two subwoofers, you can connect them to both SUBWOOFER OUT jacks.

How to connect speaker cables

Be sure to connect the speaker cables correctly to the terminals of the speaker and this receiver. Also, be sure to tightly twist the speaker wire strands and insert them securely into the speaker terminals.

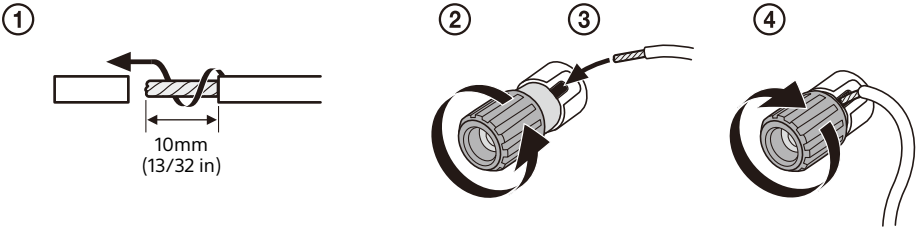

Note

- Be sure not to remove too much of the speaker cable sleeves, so as to prevent the wires of the speaker cables from touching each other.
- Connect speaker cables properly with the polarities (+/-) matched between the receiver and the speakers.

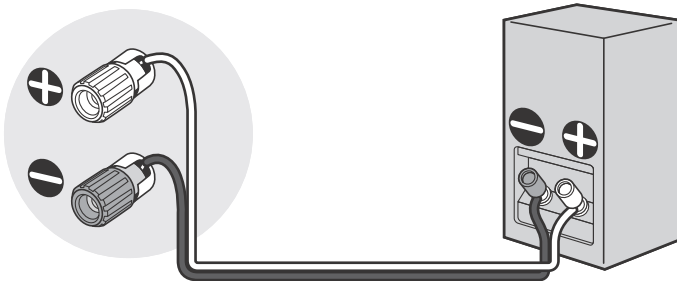

- Improper connection may result in fatal damage to the receiver.

5.1-channel speaker system

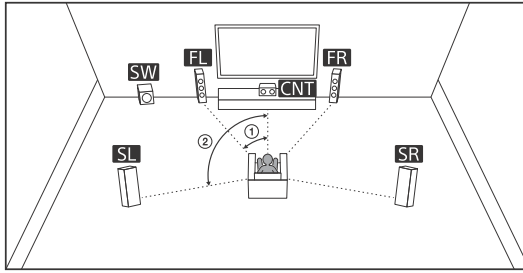

① 30° ② 100° - 120°

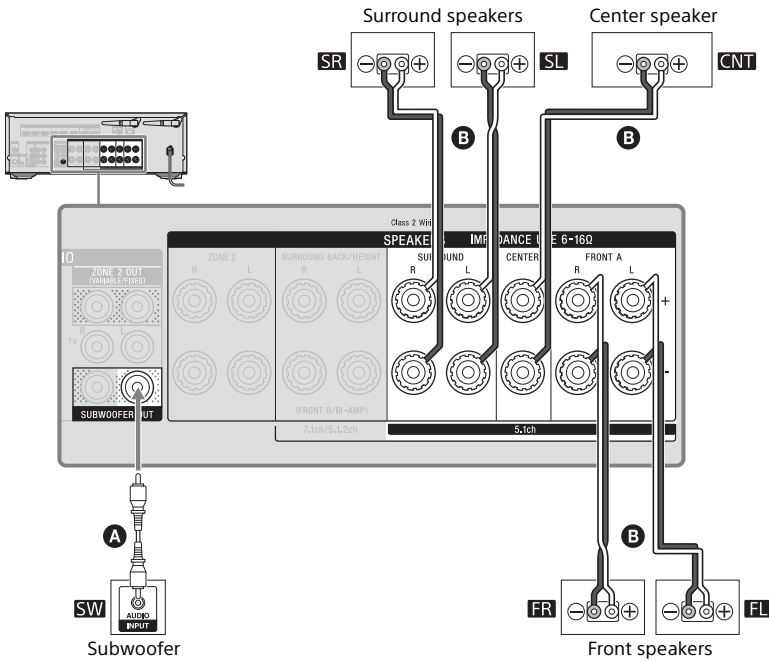

- Ⓐ Monaural audio cable (not supplied)
- Ⓑ Speaker cable (not supplied)

7.1-channel speaker system using surround back speakers

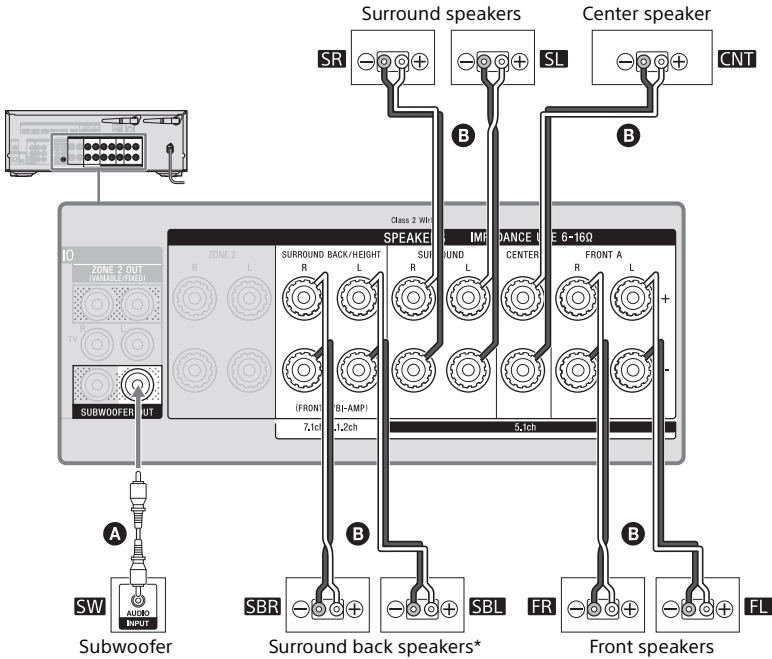
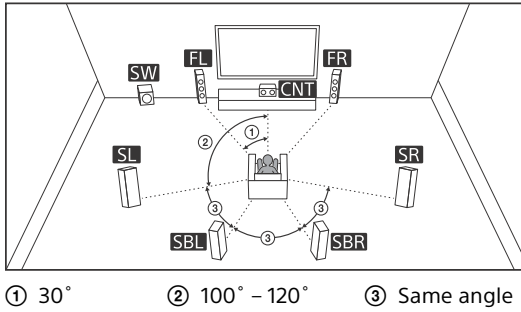

A Monaural audio cable (not supplied)

B Speaker cable (not supplied)

* If you connect only one surround back speaker, connect it to the L (+/-) terminals. After you have made the connection, select a speaker pattern with only one surround back speaker connected for [Speaker Pattern] in [Speaker Settings].

5.1.2-channel speaker system using top middle speakers

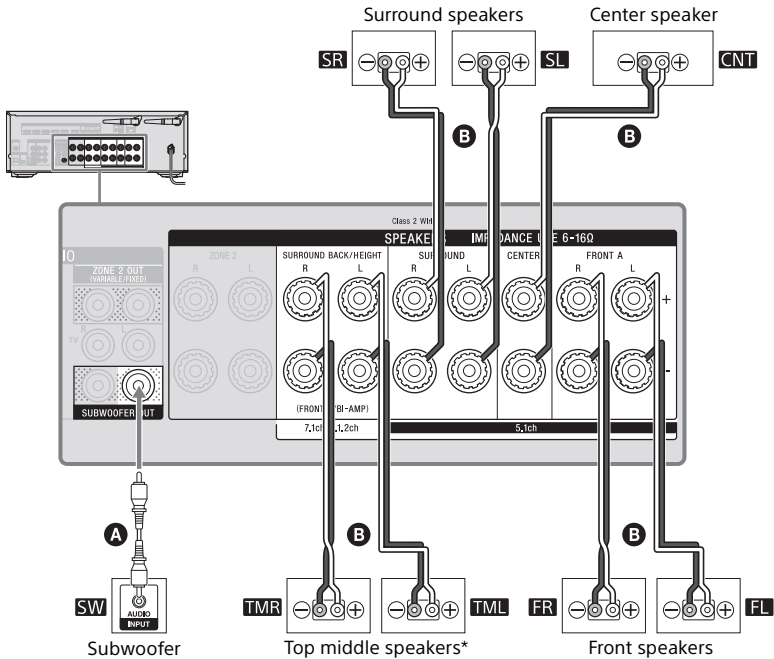
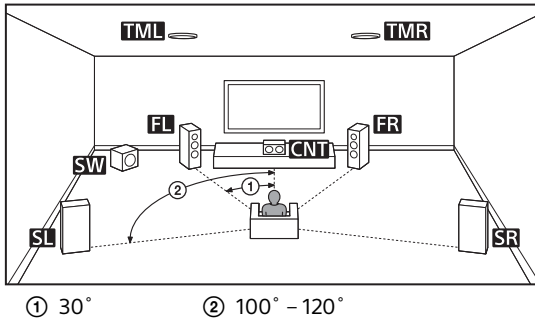

- A** Monaural audio cable (not supplied)
- B** Speaker cable (not supplied)

* After you have made the connection, set [Speaker Pattern] in [Speaker Settings] to [5.1.2 (TM)].

5.1.2-channel speaker system using Dolby Atmos enabled speakers

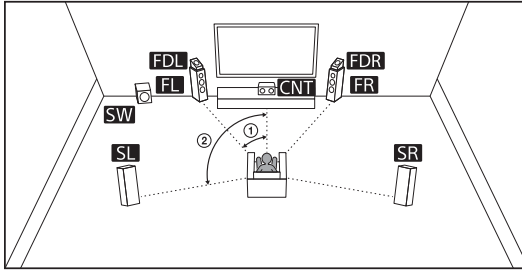

① 30°

② 100° - 120°

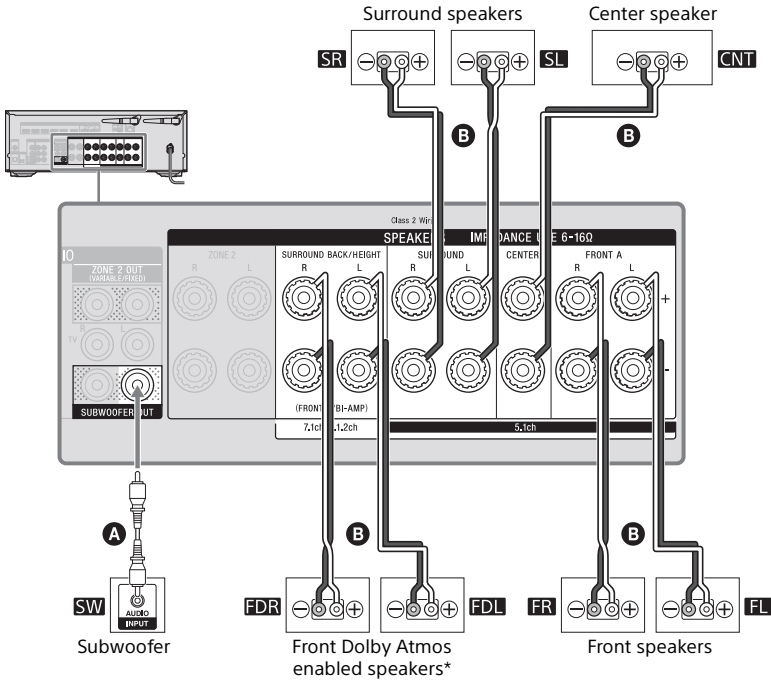

A Monaural audio cable (not supplied)

B Speaker cable (not supplied)

* After you have made the connection, set [Speaker Pattern] in [Speaker Settings] to [5.1.2 (FD)].

5.1-channel speaker system with Zone 2 speakers

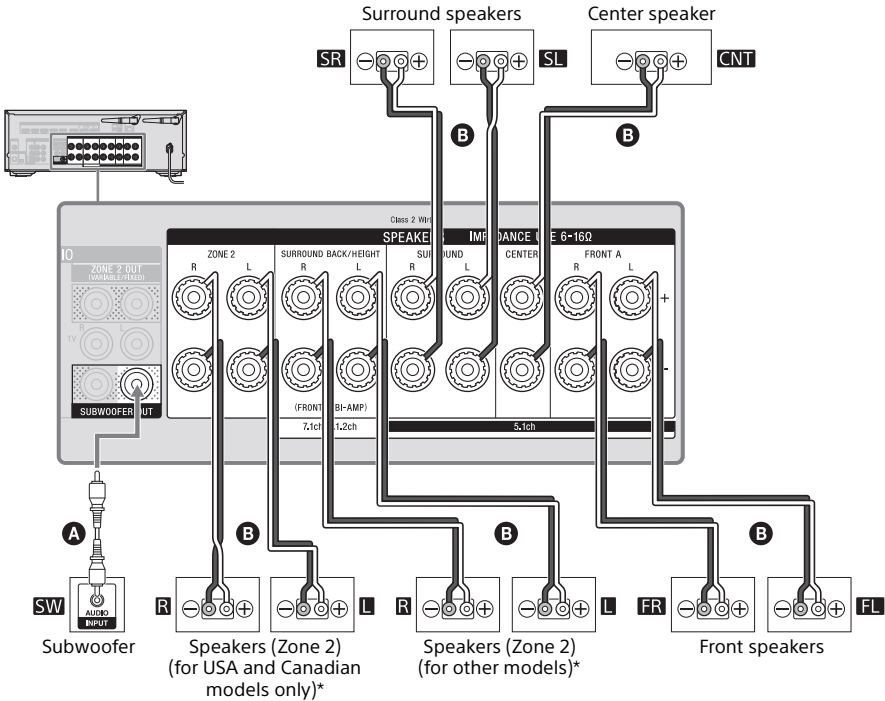
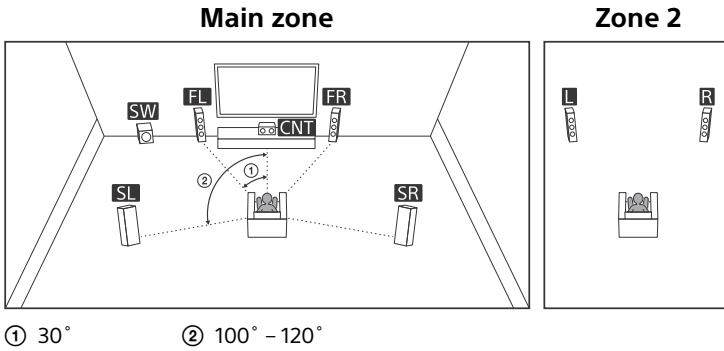

A Monaural audio cable (not supplied)

B Speaker cable (not supplied)

* Only USA and Canadian models are equipped with the SPEAKERS ZONE 2 terminals.

The USA and Canadian models are used for illustrative purposes in these Operating Instructions.

For other models, connect the speakers in Zone 2 to the SPEAKERS SURROUND BACK/HEIGHT (FRONT B/BI-AMP/ZONE 2) terminals.

For details on using the Zone 2 speakers, see "Enjoying sound from speakers located in other rooms (Zone 2)" (page 43).

Note

For USA and Canadian models, be sure to connect the speakers in Zone 2 to the SPEAKERS ZONE 2 terminals.

5.1-channel speaker system with Bi-Amplifier connection

When the front speakers are Bi-wire speakers, which are equipped with separate terminals for high-frequency sounds (tweeter) and low-frequency sounds (woofer), you can make the bi-amplifier connection. Connect each pair of terminals for tweeter and woofer to the SPEAKERS FRONT A terminals and SPEAKERS SURROUND BACK/HEIGHT terminals of this receiver. You can enjoy higher quality sound playback if you operate the tweeter and woofer using separate amplifiers.

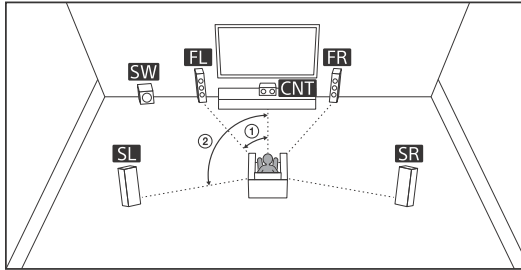

① 30° ② 100° - 120°

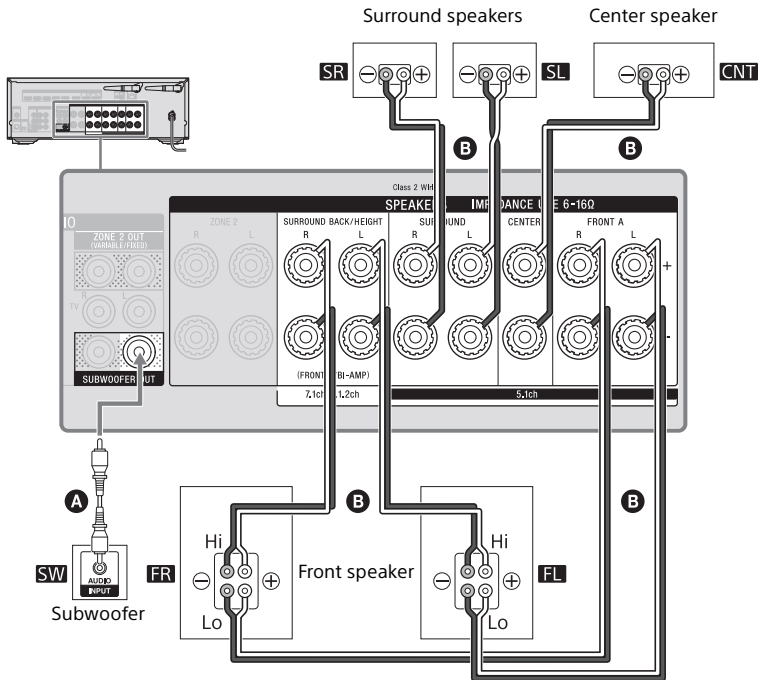

A Monaural audio cable (not supplied)

B Speaker cable (not supplied)

Make sure that metal fittings of Hi/Lo attached to the speakers have been removed from the speakers to avoid receiver malfunction.

After you have made the connection, set [Surround Back Speaker Assign] in [Speaker Settings] to [BI-AMP].

Note

You can only set [Surround Back Speaker Assign] if the speaker pattern is set to a setting that does not have surround back and height/overhead speakers (page 19).

2.1-channel speaker system (for enjoying Front Surround)

If you select [Front Surround] for the sound field setting, you can enjoy virtual surround effects using only the two front speakers.

Place the speakers as shown below to enjoy Front Surround.

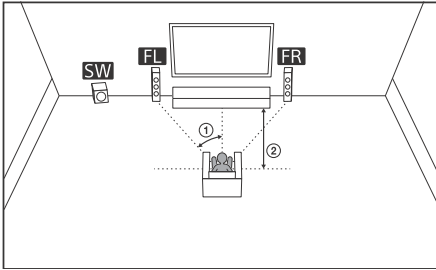

① 30°

② 1.5 m – 3 m

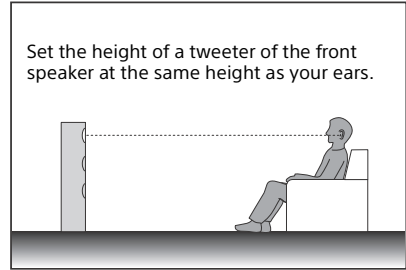

Set the height of a tweeter of the front speaker at the same height as your ears.

Tip

Change the direction of the front speakers little by little to search for and set the direction that gives you the best surround effects.

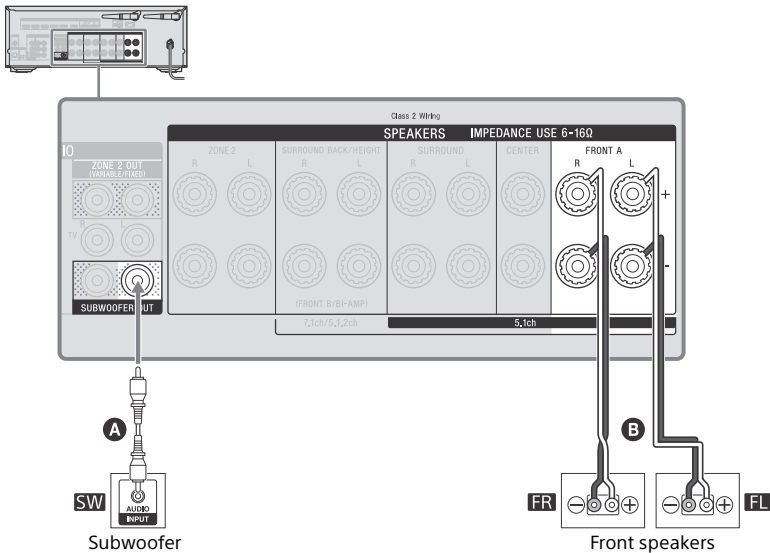

A Monaural audio cable (not supplied)

B Speaker cable (not supplied)

Connecting a TV

Connect a TV to the HDMI OUT or MONITOR OUT jack.

The menu is displayed on the TV screen only when you connect the TV to the HDMI OUT jack. Sony recommends that you use the HDMI OUT jack to connect the TV because in many cases you will have to perform the settings of this receiver using the menu.

For a 4K TV connection, visit the Help Guide.

Notes on connection

- Before connecting cables, be sure to disconnect the AC power cord (mains lead).
- Sony recommends that you use an HDMI cable made by Sony or another HDMI-authorized cable. Be sure to use a High Speed HDMI Cable with Ethernet. For video signals that require a high bandwidth such as 4K/60p 4:4:4, 4:2:2 and 4K/60p 4:2:0 10 bit etc., be sure to use a Premium High Speed HDMI Cable with Ethernet, which supports bandwidths up to 18 Gbps.
- When you use high bandwidth video formats such as 4K/60p 4:4:4, 4:2:2 and 4K/60p 4:2:0 10 bit, be sure to set the HDMI signal format. For details, see "Setting HDMI signal format" (page 42).
- We do not recommend using an HDMI-DVI conversion cable. If you connect an HDMI-DVI conversion cable to a DVI-D device, the sound and/or image may be lost. Connect separate audio cables or digital connecting cables, then reassign the input jacks if the sound is not output correctly.
- Depending on the status of the connection between the TV and the antenna (aerial), the image on the TV screen may be distorted. If this is the case, place the antenna (aerial) farther away from the receiver.
- When connecting an optical digital cable, insert the plugs straight until they click into place.
- Do not bend or tie optical digital cables.
- All of the digital audio jacks are compatible with 32 kHz, 44.1 kHz, 48 kHz, and 96 kHz sampling frequencies.
- When connecting a TV to the receiver via the TV IN jacks of the receiver, set the sound output jack of the TV to "Fixed" if it can be switched between "Fixed" or "Variable."
- When you connect the TV to HDMI OUT B/HDMI ZONE jack, be sure to set [HDMI Out B Mode] to [Main] in the [HDMI Settings] menu. The home menu is not displayed on the TV screen if [HDMI Out B Mode] is set to [Zone].

Connecting a TV incompatible with the Audio Return Channel (ARC) function via an HDMI connection

When you connect the receiver to a TV using the HDMI cable **C**, the receiver can output audio and video signals to the TV. Note, however, that you also need to connect the optical digital cable **A** or audio cable **B** to the TV in order to output TV audio from the speakers connected to the receiver.

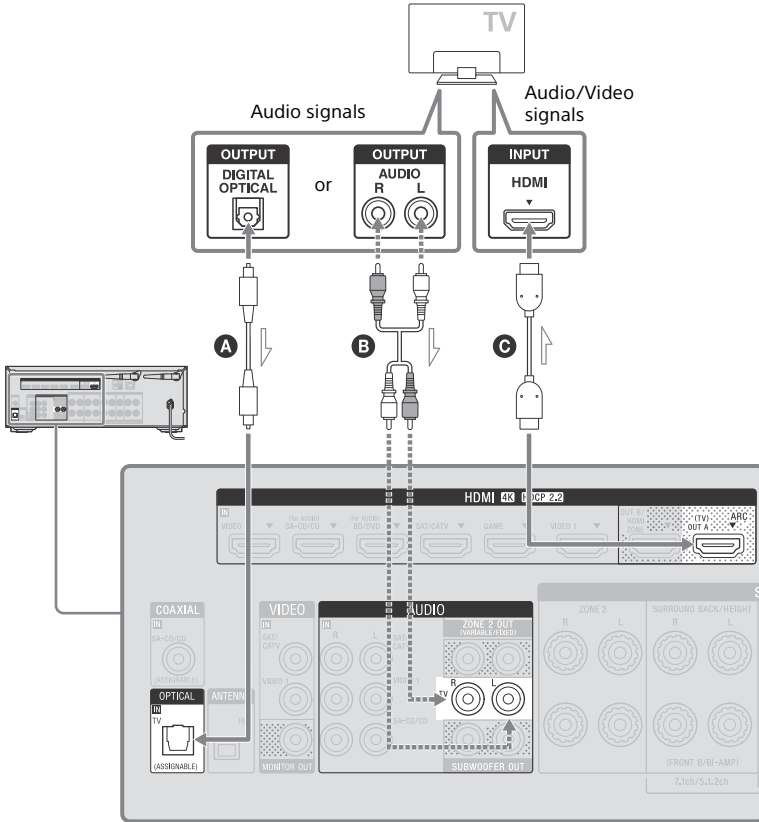

—— Recommended connection
 - - - - Alternative connection

- A** Optical digital audio cable (not supplied)
- B** Audio cable (not supplied)
- C** HDMI cable (not supplied)

Connecting a TV compatible with the Audio Return Channel (ARC) function via an HDMI connection

With just one HDMI cable connection, you can listen to the TV audio from the speakers connected to the receiver while the receiver sends audio and video signals to the TV.

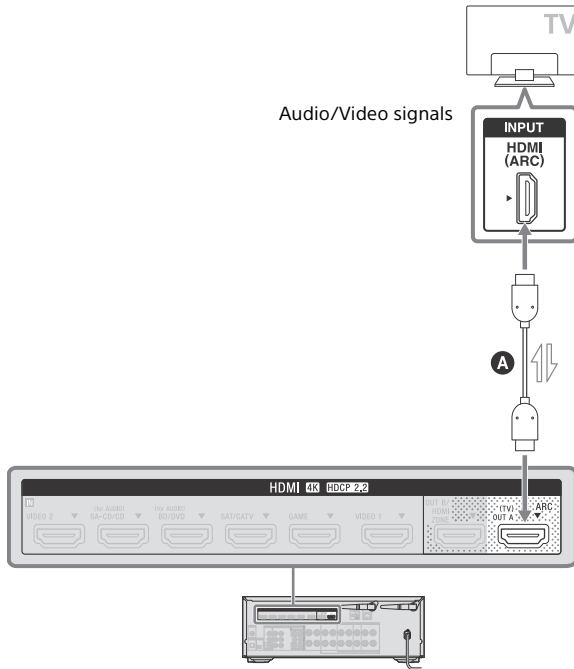

A HDMI cable (not supplied)

Note

- For this connection, you need to turn the Control for HDMI function on. Press HOME, then select [Setup] - [HDMI Settings] - [Control for HDMI] - [On].
- You also need to perform the setting on the TV menu. Turn on the ARC function.

Tip

If the HDMI jack of the TV (labeled "ARC") is already connected to another device, disconnect the device and connect the receiver.

Connecting a TV without HDMI jacks

You need to connect the optical digital audio cable **C** or audio cable **B** to the TV in addition to connecting the video cable **A**.

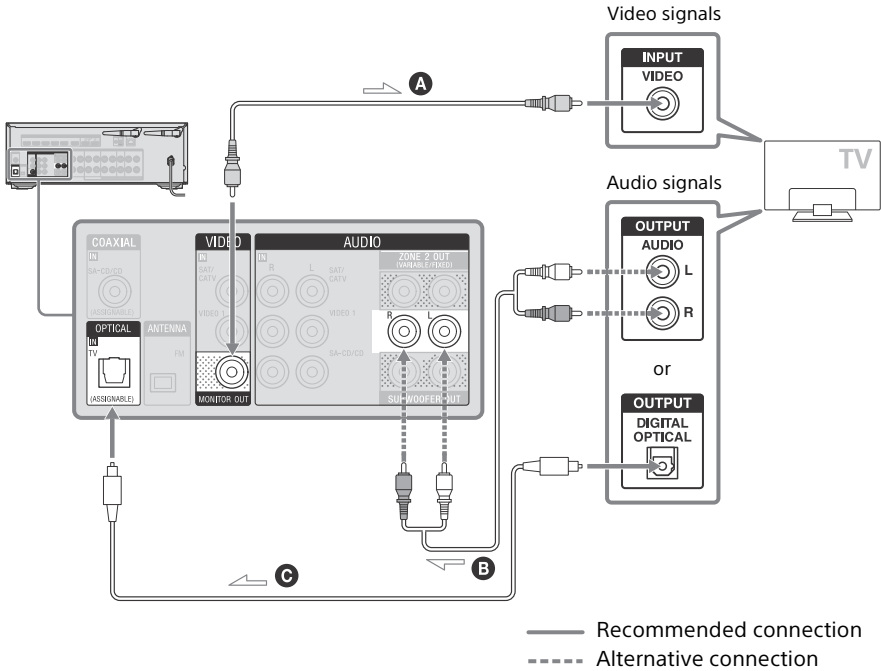

- A** Video cable (not supplied)
- B** Audio cable (not supplied)
- C** Optical digital audio cable (not supplied)

Note

- When you have connected the receiver and TV using the above method, video from the device connected to the VIDEO IN jacks is displayed on the TV.
- When you connect the receiver and TV using the above method, the menu is not displayed on the TV screen. To perform operations using the menu, you need to connect the TV via an HDMI connection.

Connecting Audio-Visual Devices

Connecting devices with HDMI jacks

Before connecting cables, be sure to disconnect the AC power cord (mains lead). The HDMI IN jacks of the receiver are compatible with HDCP 2.2. To watch content protected by HDCP 2.2, such as 4K content, connect these HDMI IN jacks to HDCP 2.2-compatible HDMI jacks on the player. Refer to the operating instructions of the connected device for details.

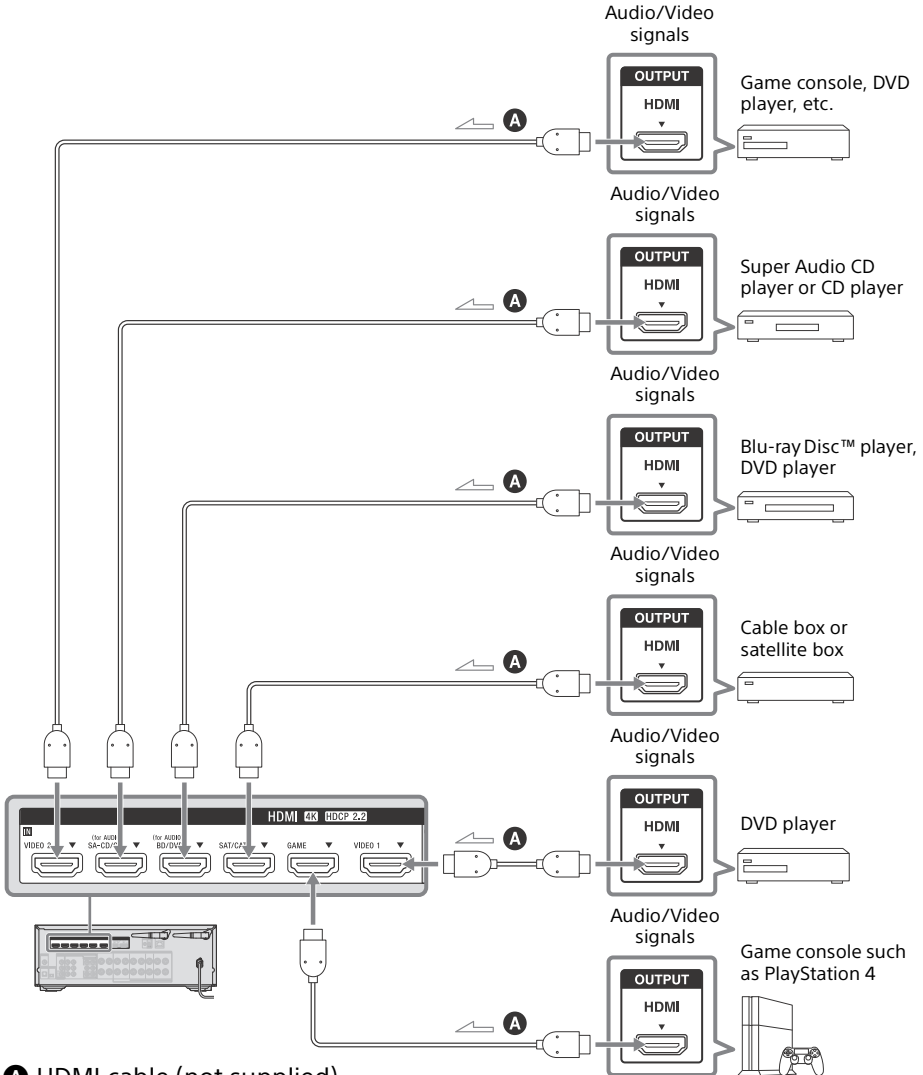

A HDMI cable (not supplied)

Tip

- This connection is an example. You can connect each HDMI device to any HDMI IN jacks.
- The BD/DVD and SA-CD/CD inputs have better sound quality. When you need a higher sound quality, connect your device to these HDMI IN jacks and select them as the input.
- The image quality depends on the type of connecting jack. We recommend you connect your devices via an HDMI connection if they have HDMI jacks.

Connecting devices with jacks other than HDMI jacks

Before connecting cables, be sure to disconnect the AC power cord (mains lead).

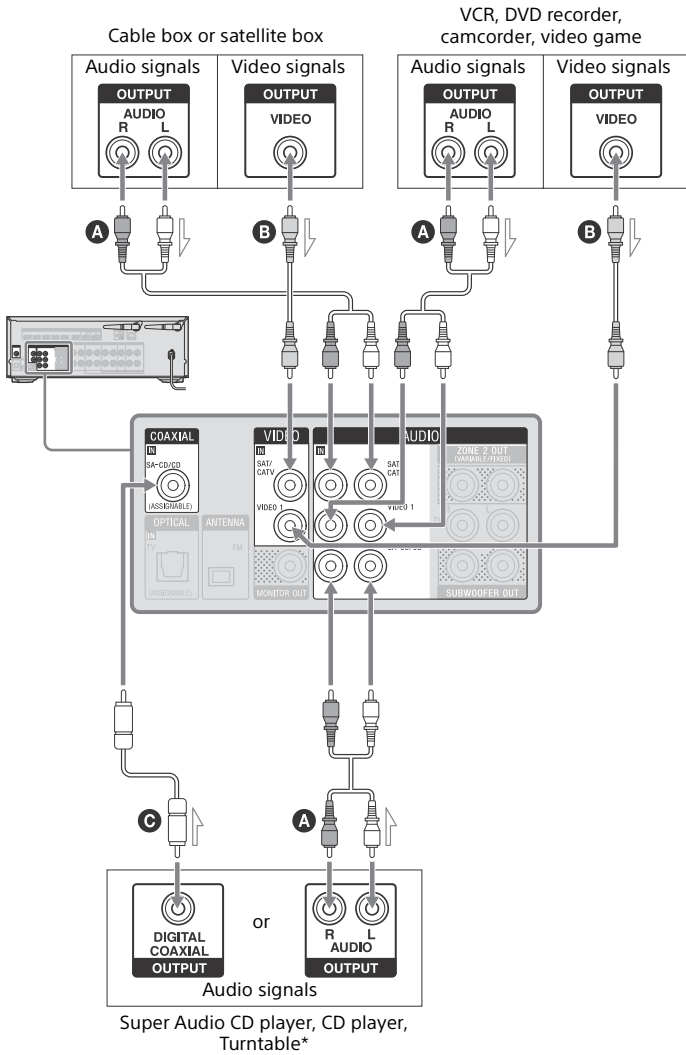

- A** Audio cable (not supplied)
- B** Video cable (not supplied)
- C** Coaxial digital cable (not supplied)

* To connect a turntable that only has a PHONO output jack, you need to connect a phono equalizer (not supplied) between the turntable and this receiver.

Note

To listen to the sounds from a device connected to the AUDIO IN jacks, do not connect any device to the HDMI IN, COAXIAL IN, and OPTICAL IN jacks, which are labeled with the same device name (such as SAT/CATV, TV, VIDEO 1, and SA-CD/CD).

Tip

- You can connect devices other than those indicated above to the AUDIO IN jacks (SAT/CATV, VIDEO 1, and SA-CD/CD).
- You can rename each input so that the name can be displayed on the display panel of the receiver. For details, refer to "Changing the name for each input (Name)" in Help Guide.

Connecting another amplifier in Zone 2

Before connecting cables, be sure to disconnect the AC power cord (mains lead).

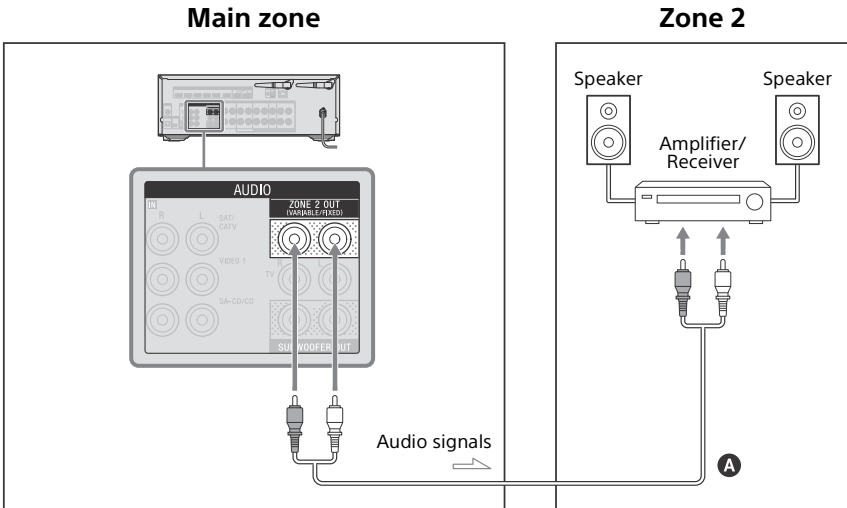

A Audio cable (not supplied)

Note

- Only audio signals from [USB], [Bluetooth] (only when [Bluetooth Mode] is set to [Receiver]), [Home Network], [Music Service List], and [FM TUNER] and audio signals input from AUDIO IN jacks located on the rear panel of the receiver are output to the Zone 2 speakers.
- External digital input from OPTICAL IN, COAXIAL IN and HDMI IN jacks cannot be output to Zone 2.
- If you set [DSD Native] in [Audio Settings] to [On], no audio signals for DSD content from [USB] or [Home Network] are output to the Zone 2 speakers.

Connecting another amplifier or TV in the HDMI zone

Before connecting cables, be sure to disconnect the AC power cord (mains lead).

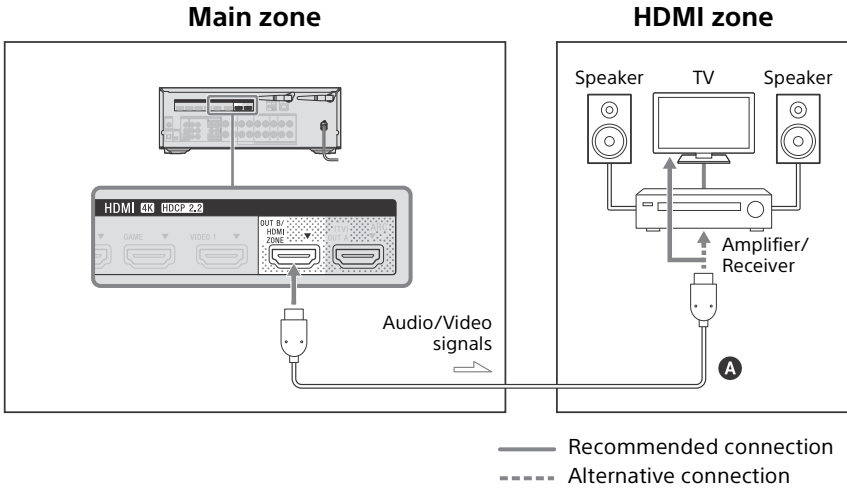

A HDMI cable (not supplied)

Note

To use this connection, set [HDMI Out B Mode] in the [HDMI Settings] menu to [Zone].

Connecting to a network

Select the connection method based on your LAN (Local Area Network) environment. The following illustrations are configuration examples of a home network with the receiver and a server.

When using wired LAN connection

Connect your receiver to the network using a LAN cable* (not supplied).

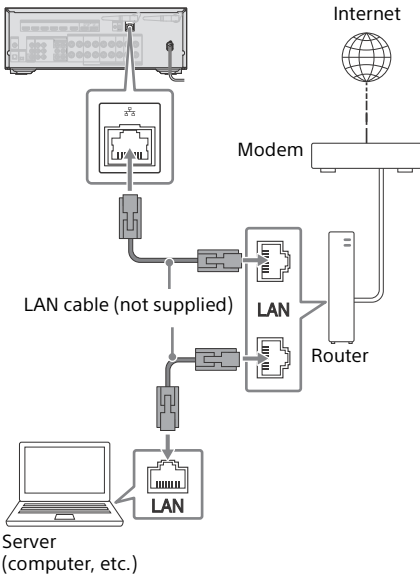

* We recommend using category 7 cables.

When using wireless LAN connection

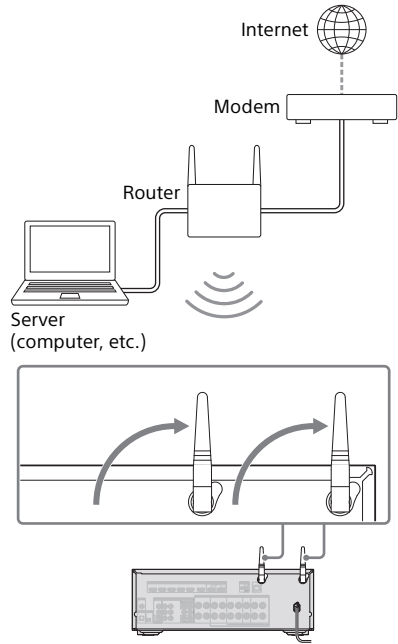

Note

- Audio playback on a server may occasionally be interrupted if you use a wireless connection.
- When using a wireless connection, stand up both wireless LAN antennas for better performance.

Connecting the Antenna (aerial)

Before connecting the antenna (aerial), be sure to disconnect the AC power cord (mains lead).

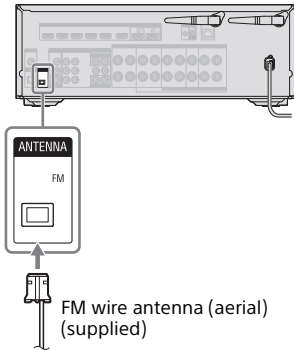

Note

- Be sure to fully extend the FM wire antenna (aerial).
- After connecting the FM wire antenna (aerial), keep it as horizontal as possible.

Connecting the AC Power Cord (mains lead)

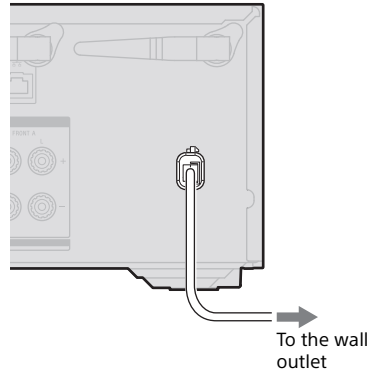

Before connecting the AC power cord (mains lead), be sure to make connections for speakers and the other devices.

1 Connect the AC power cord (mains lead) to a wall outlet.

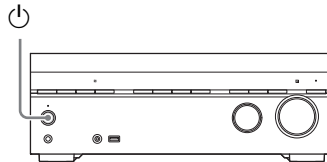

2 Press (power) to turn on the receiver.



You can also turn on the receiver using  (power) on the remote control. To turn off the receiver, press  (power) again.

Setting up the Receiver using the Easy Setup

To perform initial setup of the receiver, make sure a TV is connected to the receiver (page 29). Then, switch the input of the TV to the input to which the receiver is connected.

Note

It is not possible to perform the Easy Setup procedure using the indications on the front display panel.

When you turn on the receiver for the first time or after the receiver is initialized, the Easy Setup screen appears on the TV screen. Follow the on-screen instructions to make the basic settings using $\uparrow/\downarrow/\leftarrow/\rightarrow$ and \oplus .

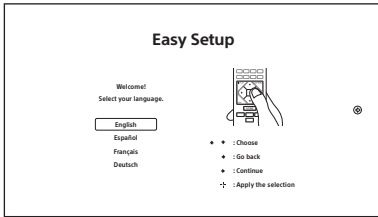

If the Easy Setup screen does not appear or you want to display the Easy Setup screen manually, you can display it by pressing HOME, then select [Setup] – [Easy Setup].

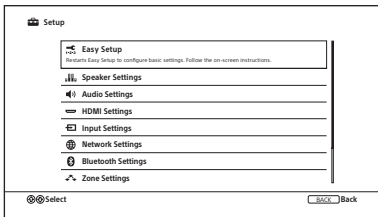

What you can do with Easy Setup

By performing Easy Setup, you can complete:

- 1: Language selection
- 2: Speaker settings
Check your speaker system and perform Auto Calibration according to the configuration and arrangement of your speaker system.
- 3: Internet settings
Select the network connection method and configure settings to connect the receiver to the network.

Performing Auto Calibration (D.C.A.C. EX)

Before you perform Auto Calibration

- Disconnect the headphones.
- Remove any obstacles between the calibration microphone and the speakers.
- Auto Calibration is not available when [Bluetooth Mode] is set to [Transmitter].
- For accurate measurement, make sure the environment is quiet and free from noise.
- Set the speaker output to a setting other than "SPK OFF." See "Selecting the front speakers" (page 41).
- Confirm the active subwoofer setup
 - Before using a subwoofer, turn on the subwoofer and turn up the volume. Turn the LEVEL to just before the mid-point.
 - When a subwoofer with a crossover frequency function is connected, set the value to maximum.
 - When a subwoofer with an auto standby function is connected, set it to off (deactivated).

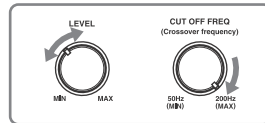

Note

Depending on the characteristics of the subwoofer you are using, the setup distance value may be different from the actual position.

- Connect the supplied calibration microphone to CALIBRATION MIC jack. Set up the calibration microphone at your listening position.

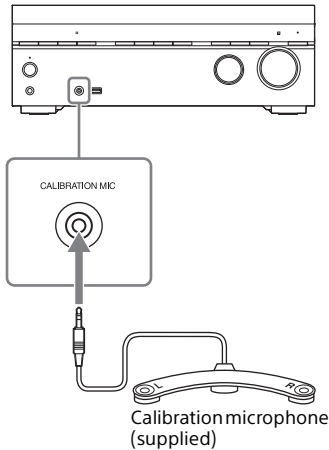



Note

- The speakers emit very loud sound during the calibration and the volume cannot be adjusted. Be considerate of your neighbors and any children who are present.
- If the muting function has been activated before you perform Auto Calibration, the muting function will shut off automatically.
- It may not be possible to take the correct measurements or to perform Auto Calibration at all if special speakers such as dipole speakers are used.
- If the measurement fails, follow the message, then select [Retry]. For details on the error code and warning message, see "List of messages after Auto Calibration measurements" (page 57).

To cancel Auto Calibration

The Auto Calibration function will be canceled when you perform the following during the measurement process:

- Press  (power).
- Press the input buttons on the remote control or turn the INPUT SELECTOR on the receiver.
- Press  (muting), MUSIC or AMP MENU.
- Press SPEAKERS on the receiver.
- Change the volume level.
- Connect the headphones.

Selecting the front speakers

SPEAKERS

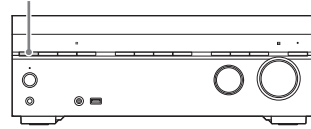

Press SPEAKERS repeatedly.

The indicators on the display panel shows which set of terminals are selected.

- **SPA**: Speakers connected to the SPEAKERS FRONT A terminals.
- **SPB***: Speakers connected to the SPEAKERS SURROUND BACK/HEIGHT(FRONT B/ BI-AMP) terminals.
- **SPA+B***: Speakers connected to both the SPEAKERS FRONT A and SPEAKERS SURROUND BACK/HEIGHT(FRONT B/ BI-AMP) terminals (parallel connection).
- (None): "SPK OFF" appears on the display panel. No audio signals are output from any speaker terminals.

* To select "SPB" or "SPA+B", set [Surround Back Speaker Assign] in [Speaker Settings] to [Front B].

Note

This setting is not available when headphones are connected.

Listening/Watching

Enjoying Sound and Video

Playing AV devices/Listening to FM radio

You can connect AV devices to the receiver to enjoy a wide range of content such as movies and audio.

Also, you can listen to FM broadcasts in high-quality sound through the built-in tuner.

- 1 Turn on the device you want to play.**
- 2 Turn on the receiver.**
- 3 Turn the TV on, and then switch the input of the TV to the input to which the receiver is connected.**
- 4 Press HOME.**

The home menu is displayed on the TV screen.

Depending on the TV, the home menu may take some time to appear on the TV screen.

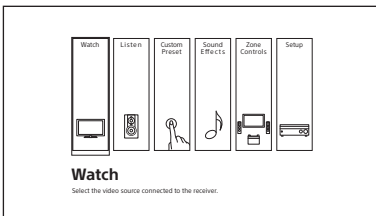

- 5 Press \leftarrow/\rightarrow to select [Watch] or [Listen], then press $\boxed{+}$.**

The menu item list appears on the TV screen.

- 6 Select the device you want to play and start playback.**

When you select [FM TUNER], tune in to your desired station by using the buttons on the remote control according to the guide on the TV screen. For details on operation, visit the Help Guide.

- 7 Press \triangleleft +/- to adjust the volume.**

You can also use MASTER VOLUME on the receiver.

Note

Before you turn off the receiver, be sure to turn down the volume level to avoid damaging your speakers the next time you turn on the receiver.

Tip

- You can turn INPUT SELECTOR on the receiver or press the input buttons on the remote control to select the device you want.
- To turn the volume up or down quickly
 - Turn the MASTER VOLUME knob quickly.
 - Press and hold one of the \triangleleft +/- buttons. To make fine adjustments
 - Turn the MASTER VOLUME knob slowly.
 - Press one of the \triangleleft +/- buttons and release it immediately.

Setting HDMI signal format

You can select a HDMI signal format according to video signals from devices connected to the HDMI IN jacks.

- 1 Press HOME, then select [Setup] - [HDMI Settings] - [HDMI Signal Format].**

- 2 Select the format you want.**

- [Standard format]: Selects this when you do not use high bandwidth video format.
- [Enhanced format]: Selects this when you use high bandwidth video formats such as 4K/60p 4:4:4, 4:2:2 and 4K/60p 4:2:0 10 bit.

Note

- For details on the high bandwidth video format, visit the Help Guide.

- When [Enhanced format] is selected, we recommend you to use a Premium High Speed HDMI Cable with Ethernet, which can support bandwidth up to 18 Gbps.
- Some devices (cable box or satellite box, Blu-ray Disc player, and DVD player) does not work well with [Enhanced format] setting. In this case, select [Standard format].
- If your TV have similar menu for high bandwidth video format, check the setting on the TV menu when you select [Enhanced format] on this receiver. For details on the TV menu setting, refer to the operating instructions of the TV.
- Since the HDMI IN VIDEO 1 jack does not support video formats such as 4K/60p 4:4:4, 4:2:2 and 4K/60p 4:2:0 10 bit, you cannot set the HDMI signal format.

Enjoying sound from speakers located in other rooms (Zone 2)

- 1 Connect the speakers located in Zone 2 (page 25).**
- 2 Turn on the receiver.**
- 3 For USA and Canadian models: Set the priority for speaker terminals.**

Press HOME, then select [Setup] – [Speaker Settings] – [SURROUND BACK/ZONE2 Priority] – [ZONE2 Terminals].

For other models: Select a speaker pattern, and set the assignment for the speaker terminals.

- ① Press HOME, then select [Setup] – [Speaker Settings] – [Speaker Pattern].
- ② Select a speaker pattern without surround back speakers, and then select [Save].
- ③ Select [Surround Back Speaker Assign] – [Zone2].

- 4 Press HOME, then select [Zone Controls].**

- 5 Set [Zone2] – [Zone2 Power] – [On].**

You can also press ZONE SELECT on the receiver repeatedly to select "ZONE2 ON ?", then press ZONE POWER on the receiver to set.

- 6 Select [Zone2 Input], then select the source signals you want to output.**

You can also turn INPUT SELECTOR on the receiver while "2. xxxx"* appears on the display panel.

Tip

If you want to listen to the same sound as main zone in Zone 2, select [SOURCE].

- 7 Start playback on the selected input device.**

- 8 Select [Zone2 Volume], then adjust the volume.**

You can also turn MASTER VOLUME on the receiver while "2. xxxx"* appears on the display panel.

* "xxxx" is the input name.

To exit zone operation

Set [Zone2 Power] to [Off] in step 5.

Note

- Only audio signals from [USB], [Bluetooth] (only when [Bluetooth Mode] is set to [Receiver]), [Home Network], [Music Service List], and [FM TUNER] and audio signals input from AUDIO IN jacks located on the rear panel of the receiver are output to the Zone 2 speakers.
- External digital input from OPTICAL IN, COAXIAL IN and HDMI IN jacks cannot be output to Zone 2.
- If you set [DSD Native] in [Audio Settings] to [On], no audio signals for DSD content from [USB] or [Home Network] are output to the Zone 2 speakers.

Enjoying sound from speakers located in other rooms using another amplifier (Zone 2)

1 Connect another amplifier located in Zone 2 (page 36).

2 Turn on the receiver in main zone and the amplifier in Zone 2.

3 Set the volume control for Zone 2.

Press HOME, then select [Setup] – [Zone Settings] – [Zone2 Line Out] – [Variable] or [Fixed].

- [Variable]: The volume for the ZONE 2 OUT jacks can be changed. Select this when using another amplifier that does not have volume control.
- [Fixed]: The volume for the ZONE 2 OUT jacks is fixed. Select this when using another amplifier with variable volume control.

4 Press HOME, then select [Zone Controls] – [Zone2] – [Zone2 Power] – [On].

You can also press ZONE SELECT on the receiver repeatedly to select “ZONE 2”, then press ZONE POWER on the receiver.

5 Select [Zone2 Input], then select the source signals you want to output.

You can also turn INPUT SELECTOR on the receiver while “2. xxxx”* appears on the display panel.

Tip

If you want to listen to the same sound as main zone in zone 2, select [SOURCE].

6 Start playback on the selected input device.

7 Adjust the volume.

Adjust the volume using the amplifier in Zone 2.

If you set [Zone2 Line Out] to [Variable] in step 3, select [Zone2 Volume] then adjust the volume. You can also turn MASTER VOLUME on the receiver while “2. xxxx”* appears on the display panel.

* “xxxx” is the input name.

To exit zone operation

Set [Zone2 Power] to [Off] in step 4.

Enjoying video and sound in another room using a TV or another amplifier (HDMI zone)

1 Connect another amplifier or TV in other room (page 37).

2 Turn on the receiver in main zone, the amplifier and TV in HDMI zone.

3 Set the assignment for the HDMI OUT B/HDMI ZONE jack to [Zone].

Press HOME, then select [Setup] – [HDMI Settings] – [HDMI Out B Mode] – [Zone].

4 Press HOME, then select [Zone Controls] – [HDMI Zone] – [HDMI Zone Power] – [On].

You can also press ZONE SELECT on the receiver repeatedly to select “HDMI ZONE”, then press ZONE POWER on the receiver.

5 Select [HDMI Zone Input], then select the source signals you want to output.

You can also turn INPUT SELECTOR on the receiver while “H. xxxx”* appears on the display panel.

* “xxxx” is the input name.

6 Adjust the volume using the volume control on the amplifier or TV in HDMI zone.

Tip

- You can avoid possible interference to the signals in main zone by setting [Priority] to [Main Only] in the [HDMI Settings] menu. However, if the same input is selected in HDMI zone, there will be no video or audio output from HDMI zone. For details on the setting, refer to “Setting the priority for the main zone (Priority)” in Help Guide.
- The HDMI OUT B/HDMI ZONE jack supports bandwidths up to 9 Gbps if [HDMI Out B Mode] is set to [Zone] in the [HDMI Settings] menu.

To exit zone operation

Set [HDMI Zone Power] to [Off] in step 4.

Available inputs for each zone

Available inputs vary depending on the zone you have selected. Select the input you want on TV screen or display panel.

For details on the available inputs, refer to “Available inputs for each zone” in Help Guide.

For main zone

You can select all input source from every device connected to the receiver in the main zone.

For Zone 2

You cannot watch video in Zone 2. Sound is not available from devices connected to the HDMI IN jacks.

Note

- Signals from the HDMI IN, OPTICAL IN and COAXIAL IN jacks cannot be output to the speakers in Zone 2.
- You can select either [USB], [Home Network], [Music Service List] or [Bluetooth] from the main zone and Zone 2. Priority is given to the choice which has most recently been selected, even if a different choice has already been selected in one of the zones.
- If you connect BLUETOOTH headphones to the main zone while a connected device is playing and the current input in Zone 2 is [USB], [Home Network] or [Music Service List], the input for Zone 2 will change to [SOURCE]. In this case, only FM tuner and analog audio signal are output to Zone 2.
- If you connect BLUETOOTH headphones to the main zone while a connected device is playing, the BLUETOOTH headphones will be disconnected if you select [USB], [Home Network] or [Music Service List] in Zone 2.
- If you set [DSD Native] in [Audio Settings] to [On], no audio signals for DSD content from [USB] or [Home Network] are output to the Zone 2 speakers.

For HDMI zone

You can only watch video or listen to audio input from the HDMI IN jacks (except for VIDEO 1).

Enjoying Sound Effects

Selecting a sound field

When you select a sound field according to the input source and your preferences, you can enjoy the sounds with added sound field effects.

1 Press HOME.

The home menu is displayed on the TV screen.

2 Select [Sound Effects] – [Sound Field].

3 Press ←/→ to select the sound field you want, then press .

Sony recommends selecting a sound field labeled [Movie] for movies and a sound field labeled [Music] for music. For details on each sound field, see “Selectable sound fields and their effects” (page 49).

Note

- When [Bluetooth Mode] is set to [Transmitter] or while using the Wireless Multi-Room function, you cannot select sound fields.
- While listening to audio contents using Chromecast built-in, you can select [Multi Ch Stereo] or [2ch Stereo] by pressing the 2CH/MULTI on the remote control.
- When listening with headphones, only the sound field for headphones appear.
- The sound fields for movie and music may not work, depending on the input or the speaker pattern you select, or with audio formats.
- The receiver may play signals at a lower sampling frequency than the actual sampling frequency of the input signals, depending on the audio format.
- Some speakers or the subwoofer may not output sound, depending on the sound field setting.

Tip

You can also select a sound field in the following way:

- press HOME, then select [Setup] – [Audio Settings] – [Sound Field].
- press 2CH/MULTI, MOVIE, MUSIC, or FRONT SURROUND on the remote control.
- press 2CH/MULTI, MOVIE, or MUSIC on the receiver.

Relations between sound fields and speaker outputs

The list below shows which speaker outputs sound when a certain sound field is selected.

2-channel content

Sound field		Display panel	Front speakers	Center speaker	Surround speakers	Surround back speakers	Subwoofer	Height speaker
2CH/ MULTI	2ch Stereo	2CH STEREO	⊙	-	-	-	-	-
	Multi Channel Stereo	MULTI ST.	⊙	○	○	○	○ ¹⁾	○
	Direct (Analog input)	DIRECT	⊙	-	-	-	-	-
	Direct (Others)	DIRECT	⊙	-	-	-	○ ³⁾	-
	A.F.D. (Auto Format Decoding)	A.F.D.	⊙	●	●	●	○ ²⁾	● ⁴⁾
MOVIE	Dolby Surround	DOLBY SURR.	⊙	○	○	○	○ ¹⁾	○
	Neural:X	NEURAL:X	⊙	○	○	○	○ ¹⁾	○ ⁵⁾
	Front Surround	FRONT SUR.	⊙	-	-	-	○ ¹⁾	-
MUSIC	Audio Enhancer	A. ENHANCER	⊙	-	-	-	○ ³⁾	-

- : No sound is output.

⊙ : Outputs sound.

○ : Outputs sound depending on the speaker pattern setting and content to be played back.

● : For Dolby and DTS audio streams, outputs sound depending on the speaker pattern setting.
No sound is output for Linear PCM, DSD, or AAC.

¹⁾ Outputs sound when you connect a subwoofer and set the speaker pattern to a setting ([x.1]) that has an active subwoofer.

²⁾ USA and Canadian models: Outputs sound.

Other models: Outputs sound when you connect a subwoofer, set the speaker pattern to a setting ([x.1]) that has an active subwoofer, and [Small] is selected for [Size] in [Speaker Settings].

³⁾ Outputs sound when you connect a subwoofer, set the speaker pattern to a setting ([x.1]) that has an active subwoofer, and [Small] is selected for [Size] in [Speaker Settings].

⁴⁾ For DTS audio streams, no sound is output when the speaker pattern is set to [5.1.2 (TM)], [5.1.2 (FD)], or [5.1.2 (SRD)].

⁵⁾ No sound is output when the speaker pattern is set to [5.1.2 (TM)], [5.1.2 (FD)], or [5.1.2 (SRD)].

Multi-channel content

Sound field		Display panel	Front speakers	Center speaker	Surround speakers	Surround back speakers	Subwoofer	Height speaker
2CH/ MULTI	2ch Stereo	2CH STEREO	⊙	–	–	–	–	–
	Multi Channel Stereo	MULTI ST.	⊙	○	○	○	○	○ ¹⁾
	Direct	DIRECT	⊙	○	○	○	○	○ ¹⁾
	A.F.D. (Auto Format Decoding)	A.F.D.	⊙	○	○	○	○	○ ¹⁾
MOVIE	Dolby Surround	DOLBY SURR.	⊙	○	○	○	○	○
	Neural:X	NEURAL:X	⊙	○	○	○	○	○ ²⁾
	Front Surround	FRONT SUR.	⊙	–	–	–	○	–
MUSIC	Audio Enhancer	A. ENHANCER	⊙	○	○	○	○	○ ¹⁾

– : No sound is output.

⊙ : Outputs sound.

○ : Outputs sound depending on the speaker pattern setting and content to be played back.

¹⁾ For DTS audio streams, no sound is output when the speaker pattern is set to [5.1.2 (TM)], [5.1.2 (FD)], or [5.1.2 (SRD)].

²⁾ No sound is output when the speaker pattern is set to [5.1.2 (TM)], [5.1.2 (FD)], or [5.1.2 (SRD)].

Note

When no sound is heard, check that all the speakers are securely connected to the correct speaker terminals (page 20), and the correct speaker pattern (page 19) is selected.

Selectable sound fields and their effects

Sound field		Display panel	Effects of the sound field
2CH/ MULTI	2ch Stereo	2CH STEREO	Plays back 2-channel audio signals without adding any surround effects. Monaural and multi-channel audio signals are output after being converted into a 2-channel signal. This sound field is best suited for playing back audio signals as they are from two front speakers only, without adding any virtual surround effects. The sound is output from the front left/right speakers only. There is no sound from the subwoofer.
	Multi Ch Stereo	MULTI ST.	Outputs sound from all connected speakers. When 2-channel or monaural audio signals are input, the receiver outputs sound from all speakers without adding any surround effects. When multi-channel audio signals are input, sound may not be output from certain speakers depending on the speaker settings or playback content.
	Direct	DIRECT	Plays back all audio signals without adding any surround effects.
	A.F.D. (Auto Format Decoding)	A.F.D.	Decodes and plays back audio signals using the optimal processing method according to the audio signal input.
MOVIE	Dolby Surround	DOLBY SURR	Dolby Surround upmixer expands traditional audio content for playback through any multi-channel speaker configuration, including height speakers. This upmixer is a new and enhanced replacement for the popular Dolby Pro Logic II technology.
	Neural:X	NEURAL:X	Neural:X remaps stereo, 5.1, and 7.1 movies and music to match your speaker layout.
	Front Surround	FRONT SUR.	Reproduces full surround effects with only two front speakers using Sony's virtual signal processing technology.
MUSIC	Audio Enhancer	A. ENHANCER	Upscales existing sound sources to near high-resolution sound quality with DSEE HX (Digital Sound Enhancement Engine HX). This sound field makes you feel as if you are really at the recording studio or concert. DSEE HX only works on 2-channel sound sources with a sampling frequency of 44.1 kHz or 48 kHz input from the following: <ul style="list-style-type: none"> - USB - Home Network - Music Service List - Bluetooth However, it does not work during Wireless Multi-Room playback.
Headphones	Headphone(2ch)	HP 2CH	This mode is selected automatically if you use headphones (Other sound fields cannot be selected). Plays back 2-channel audio signals without adding any surround effects. Sound from monaural and multi-channel audio signals are output after being converted into a 2-channel signal.

Note

- Depending on the audio format, if you select [Direct] and play a 5.1ch source when surround speakers and two surround back speakers are connected, the same audio as that from surround speakers will be output from surround back speakers, similar to that of a 7.1ch surround system. The sound level of surround and surround back speakers are adjusted automatically for optimum balance.
- Dolby Atmos is decoded as Dolby TrueHD or Dolby Digital Plus when a sound field other than [Multi Ch Stereo], [A.F.D.], or [Dolby Surround] is selected.

Network functions

What you can do with network features

You can enjoy playing back audio content in high-quality audio from a computer or network HDD, or iPhone/iPad/iPod or other smartphone or tablet connected to your home network either wired or wirelessly.

You can also enjoy music services such as internet radio by connecting internet.

You can also control this receiver from a smartphone by using the compatible apps.

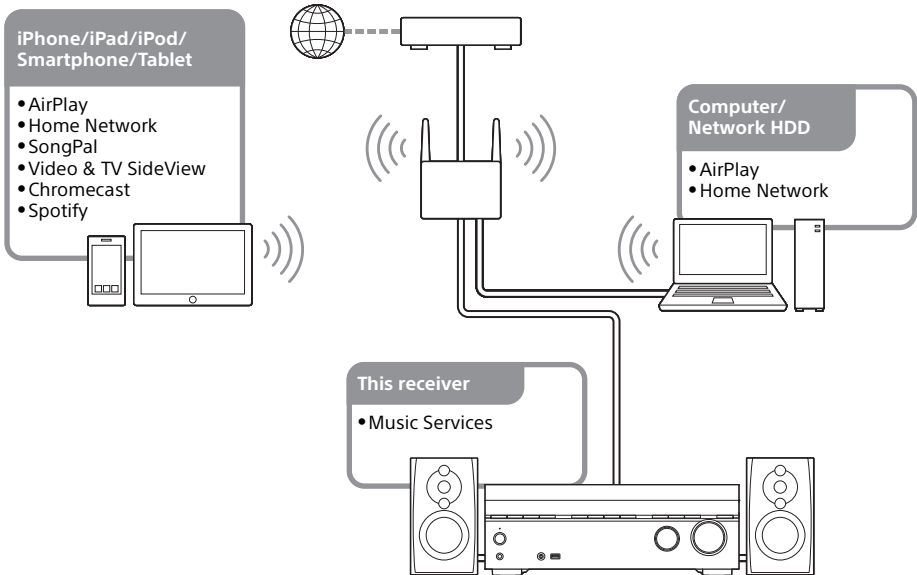

• AirPlay

This receiver supports AirPlay. You can enjoy audio content from an iPhone/iPad/iPod or your iTunes Library.

For details, refer to "Enjoying audio content from iTunes or an iPhone/iPad/iPod via the network (AirPlay)" in Help Guide.

• Home Network (DLNA)

You can play back audio content stored in various formats on a network location (computer, network HDD, etc.) via your home network.

For details, refer to "Enjoying content stored on a server on the home network (DLNA)" in Help Guide.

• SongPal

You can control your receiver wirelessly by installing the "SongPal" app on your smartphone or tablet device.

This feature is recommended when using the content playback feature, multi-zone features or SongPal Link feature of the receiver.

For details, refer to "Controlling the receiver using a smartphone or tablet device (SongPal)" in Help Guide.

- **Video & TV SideView**

You can control your receiver wirelessly by installing the Video & TV SideView app on your smartphone or tablet device. We highly recommend this app for customers who use a TV manufactured by Sony with the receiver. For details, refer to "Registering Video & TV SideView device to the receiver" in Help Guide.

- **Internet music services**

With the receiver connected to the Internet, you can listen to music from a variety of music services. For details, refer to "Enjoying music services offered on the Internet" in Help Guide.

Listening with BLUETOOTH headphones/ speakers

1 Press **BLUETOOTH RX/TX** repeatedly to select "**BT TX.**"

The BLUETOOTH mode switches to TX (transmitter).

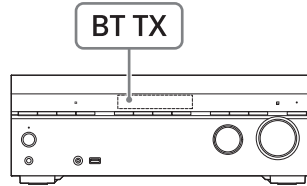

2 Turn on the headphones/speakers and set them to pairing mode.

3 Hold down **CONNECTION** **PAIRING BLUETOOTH** on the receiver for about 2 seconds.

"SEARCHING" flashes on the display panel for about 10 seconds, and then the name of detected BLUETOOTH device appears.

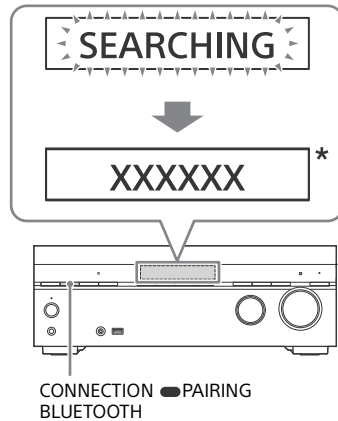

* "XXXXXX" represents the name of a detected BLUETOOTH device.

4 Press \uparrow / \downarrow to select the name of the headphones/speakers, and then press \oplus .

After "CONNECTING" flashes and the headphone name or speaker name is displayed, the BLUETOOTH connection is complete.

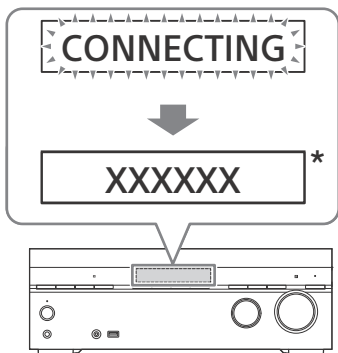

* "XXXXXX" represents the name of a detected BLUETOOTH device.

5 Press one of the input buttons to select the input you want.

The sound is output from the BLUETOOTH headphones/speakers. No sound is output from the receiver.

6 Adjust the volume of the BLUETOOTH headphones/speakers.

Volume control on the receiver and remote control only works for the BLUETOOTH headphones/speakers.

Note

- The most recently connected BLUETOOTH device can be reconnected simply by performing step 1 above.
- The one-touch connection (NFC) cannot be used in TX (transmitter) mode.
- When "NOT. USE" appears on the display panel, you cannot switch BLUETOOTH mode. Check the following:
 - BLUETOOTH function is in use
 - [Bluetooth Mode] is set to [Off]

Tip

You can also switch the BLUETOOTH mode to TX (transmitter) mode by setting [Bluetooth Mode] to [Transmitter] in [Bluetooth Settings]. Then select the name of the headphones or speakers from [Device List] in [Bluetooth Settings]. If you cannot find your device name in the list, select [Scan].

Saving power

You can save power by setting up the receiver as follows:

- Set [Control for HDMI] and [Standby Through] to [Off] in the [HDMI Settings] menu.
- Set [Remote Start] and [Network Standby] in the [Network Settings] menu to [Off] (for USA, Canadian and Oceanian models only).
- Set [Bluetooth Standby] in the [Bluetooth Settings] menu to [Off].
- Set [Zone2 Power] or [HDMI Zone Power] in the [Zone Settings] menu to [Off].

Note

If you agree to use the Chromecast built-in function, [Network Standby] automatically switches to [On] (for USA, Canadian and Oceanian models only).

Updating the Software

By updating your software to the latest version, you can take advantage of the newest functions.

The new software is available when:

- the “UPDATE” indicator lights up on the display panel.
- a message appears on the TV screen if the [Software Update Notification] is set to [On].

Note

Do not turn the receiver off or disconnect the AC power cord (mains lead) and the LAN cable until the download and update processes are completed. Doing so may cause a malfunction.

1 Press HOME.

The home menu is displayed on the TV screen.

2 Select [Setup] – [System Settings].

3 Select [Software Update].

4 Select [Update via Internet] or [Update via USB Memory].

If you select [Update via USB Memory], please visit the following customer support website to download the latest software version.

For customers in the USA:
<http://esupport.sony.com/>

For customers in Canada:
<http://esupport.sony.com/CA/>

For customers in Europe:
www.sony.eu/support

For customers in Asia-Pacific countries and regions:

<http://www.sony-asia.com/section/support>

5 Update the software.

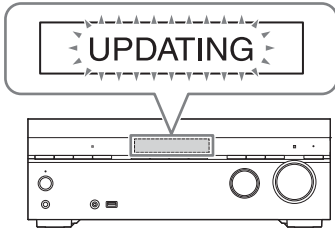

"UPDATING" flashes on the display panel during the software update process. However, "UPDATING" may disappear temporarily during updating.

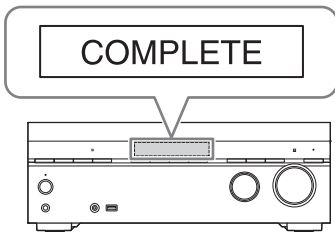

When the update is completed, "COMPLETE" appears on the display panel and the receiver restarts automatically.

Note

- It may take about 1 hour for the update to be completed.
- You cannot restore the old version after updating the software.
- Set [Auto Update] to [On] when you want to perform software updates automatically. Depending on the contents of the updates, software update may be performed even if you set [Auto Update] to [Off].

Troubleshooting

If a problem occurs while operating the receiver, check the following to resolve the problem before consulting your nearest Sony dealer.

- Check to see if the problem is listed in this "Troubleshooting" section.
- Visit the Help Guide for detailed examples. You can search by a keyword using the online troubleshooting guide.

For the customers in Europe:

http://rd1.sony.net/help/ha/strdn108/h_eu/

For the customers in other areas:

http://rd1.sony.net/help/ha/strdn108/h_zz/

If the problem persists after doing all of the above, consult your nearest Sony dealer.

General

The receiver is turned off automatically.

- If [Auto Standby] is set to [On], set it to [Off].
- The sleep timer function was activated.
- "PROTECTOR" was activated.

The indicator on the display panel turns off.

- If the PURE DIRECT indicator on the front panel lights up, press PURE DIRECT to turn off this function.
- Press DIMMER on the receiver to adjust the brightness of the display panel.

Video

No image appears on the TV screen.

- Try pressing the input button on the remote control or turning INPUT SELECTOR on the receiver to select the input to which you want to listen.
- Set your TV to the appropriate input mode.
- Move your audio device away from the TV.
- Make sure that cables are correctly and securely connected to devices.
- Disconnect the HDMI cable from the receiver and TV and then reconnect the cable.

- Set [HDMI Signal Format] of the selected input to [Standard format] in the [HDMI Settings] menu.
- Some playback devices need to be set up. Refer to the operating instructions supplied with each device.
- Be sure to use a High Speed HDMI Cable with Ethernet when you view images or listen to sound, especially for 1080p, Deep Color (Deep Colour), 4K or 3D transmission. Premium High Speed HDMI Cable with Ethernet, which can support bandwidths up to 18 Gbps, is required for 4K/60p 4:4:4, 4:2:2 and 4K/60p 4:2:0 10 bit, etc.
- The output of the HDMI video signals of the receiver may be set to "HDMI OFF." In this case, set to "HDMI A", "HDMI B", or "HDMI A + B" by pressing HDMI OUT on the remote control.
- If you want to play HDCP 2.2 content, connect the receiver to an HDMI input jack of a TV that is compatible with HDCP 2.2.

No 3D content appears on the TV screen.

- Depending on the TV or the video device, 3D content may not be displayed. For details on the 3D HDMI video format supported by the receiver, visit the Help Guide.
- Be sure to use a High Speed HDMI Cable with Ethernet.

No 4K content appears on the TV screen.

- Depending on the TV or the video device, 4K content may not be displayed. Check the video capability and settings of your TV and video device.
- Be sure to use a High Speed HDMI Cable with Ethernet.
- When you use high bandwidth video formats such as 4K/60p 4:4:4, 4:2:2 and 4K/60p 4:2:0 10 bit, a Premium High Speed HDMI Cable with Ethernet, which can support bandwidth up to 18 Gbps, is required.
- If your TV have similar menu for high bandwidth video format, check the setting on the TV menu when you select [Enhanced format] (page 42) on this receiver. For details on the TV menu setting, refer to the operating instructions of the TV.
- Be sure to connect the receiver to an HDMI input jack of a TV or video device that is supporting 4K. You have to connect an

HDMI cable to an HDMI jack that supports HDCP 2.2 when you use a playback device for 4K resolution video content, etc.

The home menu does not appear on the TV screen.

- The home menu can only be used when you connect the TV to the HDMI OUT jack on the receiver.
- When you connect the TV to HDMI OUT B/ HDMI ZONE jack, be sure to set [HDMI Out B Mode] to [Main] in the [HDMI Settings] menu.
- Press HOME to display the home menu.
- Check that the TV is connected correctly.
- Disconnect the HDMI cable from the receiver and TV and then reconnect the cable.
- The home menu may take some time to appear on the TV screen depending on the TV.

HDR (High Dynamic Range) images cannot be displayed in HDR mode.

- Depending on the TV or video equipment, HDR images may not be displayed in HDR mode. Check the video capability and setting of your TV or video equipment.
- Some video equipment may not output HDR contents in HDR mode if [HDMI Signal Format] is set to [Standard format], even if both TV and video equipment support HDR and 18 Gbps band width. In this case set [HDMI Signal Format] of selected input to [Enhanced format] in the [HDMI Settings] menu. When you select [Enhanced format], use Premium High Speed HDMI cables with Ethernet which can support bandwidth up to 18 Gbps.

Audio

No sound or only a very low level of sound is heard, no matter which device is selected.

- Check that all connecting cables are inserted to their input/output jacks on the receiver, speakers and the devices.
- Check that the receiver and all devices are turned on.
- Check that MASTER VOLUME on the receiver is not set to "VOL MIN."
- Press SPEAKERS on the receiver to select a setting other than "SPK OFF" (page 41).

- Check that headphones are not connected to the receiver.
- Press **M** (muting) to cancel the muting function.
- Try pressing the input button on the remote control or turning INPUT SELECTOR on the receiver to select the input to which you want to listen.
- If you want to listen to sound from the TV speaker, set [Audio Out] to [TV + AMP] in the [HDMI Settings] menu. If you cannot play multi-channel audio source, set [AMP]. However, the sound will not be output through the TV speaker.
- Sound may be interrupted when the sampling frequency, number of channels or audio format of audio output signals from the playback device is switched.
- If you are listening with BLUETOOTH headphones, check that the [Bluetooth Mode] is set to [Transmitter].
- Sound for the center channel is not output if you set the speaker pattern to a setting that does not have a center speaker or when [DSD Native] is set to [On] and a DSD multi-channel source is being played back.
- Sound for surround left/right channels is not output if you set the speaker pattern to a setting that does not have surround speakers or when [DSD Native] is set to [On] and a DSD multi-channel source is being played back.
- No sound from [USB], [Bluetooth] (only when [Bluetooth Mode] is set to [Receiver]), [Home Network], and [Music Service List] is output to the Zone 2 speakers if you set [DSD Native] in [Audio Settings] to [On].

When a TV is connected to the receiver via an HDMI OUT A (TV) jack that supports the Audio Return Channel (ARC) function, sound from the TV is not output from the speakers connected to the receiver.

- Set [Control for HDMI] to [On] in the [HDMI Settings] menu.
- Make sure that your TV is compatible with the Audio Return Channel function.
- Make sure that the HDMI cable is connected to a jack on your TV that is compatible with the Audio Return Channel function.
- Set the Audio Return Channel (ARC) function of your TV to on.

The surround effect cannot be obtained.

- Be sure to select the optimal sound field for the content. For details on the sound fields, see "Selectable sound fields and their effects" (page 49).
- [Dolby Surround] and [Neural:X] do not work when the speaker pattern is set to [2.0] or [2.1].

The sound lags behind the picture.

When you listen to sound from one of the following sources and watch video using the Wireless Multi-Room function, the sound is delayed in order to synchronize it with the sound output from the speakers in another location.

- Ⓐ Devices connected to the HDMI IN, OPTICAL IN, COAXIAL IN, or AUDIO IN jacks
- Ⓑ TVs compatible with the Audio Return Channel (ARC) function and connected to the HDMI OUT A (TV) jack

If the sound lag bothers you, deactivate the synchronization with speakers in another location* by the following procedure.

- * If you deactivate the synchronization with other speakers, the sound and video output from the receiver will be synchronized, but the sound output from speakers in another location will be delayed.

If sound is input from Ⓐ:

- 1 Press **OPTIONS**.
The options menu appears.
- 2 Select [**Multi-room Sync**] - [**Off**].

If sound is input from Ⓑ:

- 1 Press **AMP MENU**.
The menu is displayed on the display panel of the receiver.
- 2 Press **↑/↓** and **+** to select "<AUDIO>" (Audio Settings) - "M/R SYNC" - "OFF."

Network connection

Cannot connect to the network using WPS via a wireless LAN connection.

You cannot connect to a network using [Wi-Fi Protected Setup™ (WPS)] if your access point is set to WEP. Set up your network after searching the access point using the access point scan.

Cannot connect to the network.

- Check that the LAN cable is connected to the receiver when you want to connect the receiver to the network via a wired LAN connection.
- Check the network information. If the connection failed, set up the network connection again.
- If the receiver is connected through a wireless network, move the receiver and the wireless LAN router/access point closer to each other and perform the setup again.
 - Make sure that you use a wireless LAN router/access point.
 - Make sure that the wireless LAN router/access point is turned on.
 - Check the settings of the wireless LAN router/access point and perform the setup again. For details on the settings of devices, refer to the operating instructions of the devices.
 - Wireless networks are influenced by electromagnetic radiation emitted by microwave ovens and other devices. Move the receiver away from these devices.

Cannot select the [Network Settings] menu.
Wait for a few moments after you have turned on the receiver, and then select the [Network Settings] menu again.

Error messages

"PROTECTOR" appears on the display panel.
The receiver will automatically turn off after a few seconds. Check the followings:

- There may be an electrical surge or power failure. Unplug the AC power cord (mains lead) and then plug in the cord again after 30 minutes.
- The receiver is covered and the ventilation holes are blocked. Remove the object covering the ventilation holes of the receiver.
- The impedance of the connected speakers is below the rated impedance range indicated on the back panel of the receiver. Reduce the volume level.
- Unplug the AC power cord (mains lead) and let the receiver cool down for 30 minutes

while performing the following troubleshooting:

- Disconnect all of the speakers and subwoofer.
- Check that the speaker wires are tightly twisted on both ends.
- Connect the front speaker first, increase the volume level and operate the receiver for at least 30 minutes until it completely warms up. Then, connect each additional speaker one by one and test each additional speaker until you detect which speaker is causing the protection error.

After checking the above items and fixing any problems, plug in the AC power cord (mains lead) and turn on the receiver. If the problem persists, consult your nearest Sony dealer.

[Overload occurred.] appears on the TV screen.

An over-current from the Ψ (USB) port was detected. Disconnect the USB device as prompted in the warning message and close the message.

List of messages after Auto Calibration measurements**Code 30**

Headphones are connected. Please disconnect the headphones and retry calibration.

Code 31

The front speakers are not selected correctly. Select the front speakers correctly using SPEAKERS on the receiver and perform Auto Calibration again while sound is being output. For details on selecting the front speakers, see "Selecting the front speakers" (page 41).

Code 32, Code 33

- Sound is not detected from one or both of the speakers.
 - Sound is not detected from one or both of the front speakers. Please ensure that the calibration microphone is not damaged, and is connected to the CALIBRATION MIC jack on the front panel of the receiver, and that all speakers are properly connected.

- Sound is not detected from either the left or right surround speakers. Please ensure that the surround speakers are connected to the SURROUND terminals.
- The surround back speaker is connected to the SURROUND BACK/HEIGHT R terminal. When using only one surround back speaker, please connect it to the SURROUND BACK/HEIGHT L terminals.
- Only one height speaker is detected. Please ensure that both the height speakers are connected to the SURROUND BACK/HEIGHT terminals.
- Sound is not detected from any speakers, please ensure the calibration microphone is not damaged and is connected to the CALIBRATION MIC jack on the front panel of the receiver.

Code 34

Speakers are not placed in the proper position or the calibration microphone may be reversed.

Code 35

The speaker pattern configuration does not match calibration result. Please check the speaker pattern and connection.

Warning 40

The measurement has been completed, but the noise level is high. For best results, calibrate in as quiet a place as possible.

Warning 41, Warning 42

The input signal from the calibration microphone is too large. The microphone may be too close to the speakers. Please place the calibration microphone at your desired listening position. Please note, when using the receiver as a pre-amplifier, this message may appear by mistake. Please disregard.

Warning 43

The distance and phase of the subwoofer cannot be detected. Please check the subwoofer and re-calibrate in a quiet environment.

Warning 44

The measurement has been completed, but the speaker may need to be re-positioned. Please see "Installing Speakers" in the Help Guide.

Precautions

On safety

Should any solid object or liquid fall into the cabinet, unplug the receiver and have it checked by qualified personnel before operating it any further.

On power sources

- Before operating the receiver, check that the operating voltage is identical with your local power supply. The operating voltage is indicated on the nameplate on the back of the receiver.
- If you are not going to use the receiver for a long time, be sure to disconnect the receiver from the wall outlet. To disconnect the AC power cord (mains lead), grasp the plug itself; never pull the cord.
- The AC power cord (mains lead) must be changed only at a qualified service shop.

On heat buildup

Although the receiver heats up during operation, this is not a malfunction. If you continuously use this receiver at a large volume, the cabinet temperature of the top, side and bottom rises considerably. To avoid burning yourself, do not touch the cabinet.

On placement

- Place the receiver in a location with adequate ventilation to prevent heat buildup and prolong the life of the receiver.
- Do not place the receiver near heat sources, or in a place subject to direct sunlight, excessive dust, or mechanical shock.
- Do not place anything on top of the cabinet that might block the ventilation holes and cause malfunctions.
- Do not place the receiver near device such as a TV, VCR, or tape deck. (If the receiver is being used in combination with a TV, VCR, or tape deck, and is placed too close to that device, noise may result, and picture quality may suffer. This is especially likely when using an indoor antenna (aerial).)
- Use caution when placing the receiver on surfaces that have been specially treated

(with wax, oil, polish, etc.) as staining or discoloration of the surface may result.

On operation

Before connecting other device, be sure to turn off and unplug the receiver.

On cleaning

Clean the cabinet, panel, and controls with a soft cloth slightly moistened with a mild detergent solution. Do not use any type of abrasive pad, scouring powder, or solvent, such as alcohol or benzine.

On BLUETOOTH communication

Supported BLUETOOTH version and profiles

Profile refers to a standard set of functions for various BLUETOOTH product features. See "BLUETOOTH section" in "Specifications" (page 62) for the BLUETOOTH version and profiles supported by this receiver.

Effective communication range

BLUETOOTH devices should be used within approximately 10 meters (33 feet) (unobstructed distance) of each other. The effective communication range may become shorter under the following conditions.

- When a person, metal object, wall or other obstruction is between the devices with a BLUETOOTH connection
- Locations where a wireless LAN is installed
- Around microwave ovens that are in use
- Locations where other electromagnetic waves are generated

Effects of other devices

BLUETOOTH devices and wireless LAN (IEEE 802.11b/g/n) device use the same frequency band (2.4 GHz). When using your BLUETOOTH device near a device with wireless LAN capability, electromagnetic interference may occur. This could result in lower data transfer rates, noise, or inability to connect. If this happens, try the following remedies:

- Use this receiver at least 10 meters (33 feet) away from the wireless LAN device.
- Turn off the power to the wireless LAN device when using your BLUETOOTH device within 10 meters (33 feet).
- Install this receiver and BLUETOOTH device as closer to each other as possible.

Effects on other devices

The radio waves broadcast by this receiver may interfere with the operation of some medical devices. Since this interference may result in malfunction, always turn off the power on this receiver and BLUETOOTH device in the following locations:

- In hospitals, on trains, in airplanes, at gas stations, and any place where flammable gasses may be present
- Near automatic doors or fire alarms

Note

- This receiver supports security functions that comply with the BLUETOOTH specification to ensure secure connection during communication using BLUETOOTH technology. However, this security may be insufficient depending on the setting contents and other factors, so always be careful when performing communication using BLUETOOTH technology.
- Sony shall not be held liable in any way for damages or other loss resulting from information leaks during communication using BLUETOOTH technology.
- BLUETOOTH communication is not necessarily guaranteed with all BLUETOOTH devices that have the same profile as this receiver.
- BLUETOOTH devices connected with this receiver must comply with the BLUETOOTH specification prescribed by the Bluetooth SIG, Inc., and must be certified to comply. However, even when a device complies with the BLUETOOTH specification, there may be cases where the characteristics or specifications of the BLUETOOTH device make it impossible to connect, or may result in different control methods, display or operation.
- Noise may occur or the audio may cut off depending on the BLUETOOTH device connected with this receiver, the communications environment, or surrounding conditions.

If you have any questions or problems concerning your receiver, please consult your nearest Sony dealer.

On copyrights

This receiver incorporates Dolby* Digital Surround and the DTS** Digital Surround System.

* Manufactured under license from Dolby Laboratories. Dolby, Dolby Atmos, Dolby Vision, and the double-D symbol are trademarks of Dolby Laboratories.

** For DTS patents, see <http://patents.dts.com>. Manufactured under license from DTS, Inc. DTS, the Symbol, DTS in combination with the Symbol, DTS:X, and the DTS:X logo are registered trademarks or trademarks of DTS, Inc. in the United States and/or other countries. © DTS, Inc. All Rights Reserved.

This receiver incorporates High-Definition Multimedia Interface (HDMI™) technology. The terms HDMI, High-Definition Multimedia Interface, and the HDMI Logo are trademarks or registered trademarks of HDMI Licensing, LLC in the United States and other countries.

Apple, the Apple logo, AirPlay, iPad, iPhone, iPod, iPod touch, and Retina are trademarks of Apple Inc., registered in the U.S. and other countries.

iPad Air and iPad mini are trademarks of Apple Inc.

App Store is a service mark of Apple Inc., registered in the U.S. and other countries.

"Made for iPod," "Made for iPhone," and "Made for iPad" mean that an electronic accessory has been designed to connect specifically to iPod, iPhone, or iPad, respectively, and has been certified by the developer to meet Apple performance standards. Apple is not responsible for the operation of this device or its compliance with safety and regulatory standards. Please note that the use of this accessory with iPod, iPhone, or iPad may affect wireless performance.

Windows Media is either a registered trademark or trademark of Microsoft Corporation in the United States and/or other countries.

This product is protected by certain intellectual property rights of Microsoft Corporation. Use or distribution of such technology outside of this product is prohibited without a license from Microsoft or an authorized Microsoft subsidiary.

LDAC™ and LDAC logo are trademarks of Sony Corporation.

MPEG Layer-3 audio coding technology and patents licensed from Fraunhofer IIS and Thomson.

"BRAVIA" is a trademark of Sony Corporation.

"PlayStation" is a registered trademark of Sony Computer Entertainment Inc.

"WALKMAN" and "WALKMAN" logo are registered trademarks of Sony Corporation.

MICROVAULT is a trademark of Sony Corporation.

Wi-Fi® and Wi-Fi Alliance® are registered trademarks of Wi-Fi Alliance®.

WPA™, WPA2™ and Wi-Fi Protected Setup™ are trademarks of Wi-Fi Alliance®.

DLNA™, the DLNA Logo and DLNA CERTIFIED™ are trademarks, service marks, or certification marks of the Digital Living Network Alliance.

The BLUETOOTH® word mark and logos are registered trademarks owned by Bluetooth SIG, Inc. and any use of such marks by Sony Corporation is under license. Other trademarks and trade names are those of their respective owners.

The N-Mark is a trademark or registered trademark of NFC Forum, Inc. in the United States and in other countries.

Android™, Google Play™ and Chromecast are trademarks of Google Inc.

This product incorporates Spotify software which is subject to 3rd party licenses found here*:

<https://developer.spotify.com/esdk-third-party-licenses/>

Spotify and Spotify logos are trademarks of the Spotify Group.*

* This function may not be available in some countries/regions.

All other trademarks and registered trademarks are of their respective holders. In this manual, ™ and ® marks are not specified.

Notice on End User License Agreement (EULA)

For details of the EULA for this product, see page 66.

For details of the EULA for network services, please refer to [License agreement] in options menu on each network service icon.

For details of the GPL, LGPL and other software licenses, please refer to [Software License Information] in [System Settings] of the [Setup] menu on this product.

This product contains software that is subject to the GNU General Public License ("GPL") or GNU Lesser General Public License ("LGPL"). These establish that customers have the right to acquire, modify, and redistribute the source code of said software in accordance with the terms of the GPL or the LGPL.

The source code for the software used in this product is subject to the GPL and LGPL, and is available on the Web.

To download, please access the following:
URL: <http://oss.sony.net/Products/Linux>
Please note that Sony cannot answer or respond to any inquiries regarding the content of this source code.

Specifications

AUDIO POWER SPECIFICATIONS

POWER OUTPUT AND TOTAL HARMONIC DISTORTION: (USA models only)

With 6 ohm loads, both channels driven, from 20 Hz – 20,000 Hz; rated 100 watts per channel minimum RMS power, with no more than 0.09% total harmonic distortion from 250 milliwatts to rated output.

Amplifier section¹⁾

Minimum RMS Output Power
(6 ohms, 20 Hz – 20 kHz, THD 0.09%)
100 W + 100 W

Stereo Mode Output Power
(6 ohms, 1 kHz, THD 0.9%)
120 W + 120 W

Surround Mode Output Power²⁾
(6 ohms, 1 kHz, THD 0.9%)
165 W per channel

¹⁾ Measured under the following conditions:

Area	Power requirements
USA, Canada	120 V AC, 60 Hz
Oceania, Europe	230 V AC, 50 Hz

²⁾ Reference power output for front, center, surround and surround back speakers. Depending on the sound field settings and the source, there may be no sound output.

Frequency response

Analog

10 Hz – 100 kHz, +0.5/-2 dB (with sound field and equalizer bypassed)

Input

Analog

Sensitivity: 500 mV/50 kilohms
S/N³⁾: 105 dB (A, 500 mV⁴⁾)

Digital (Coaxial)

Impedance: 75 ohms
S/N: 100 dB (A, 20 kHz LPF)

Digital (Optical)

S/N: 100 dB (A, 20 kHz LPF)

Output (Analog)

ZONE 2

Voltage: 2 V/1 kilohm

SUBWOOFER

Voltage: 2 V/1 kilohm

Equalizer

Gain levels
±10 dB, 1 dB step

³) INPUT SHORT (with sound field and equalizer bypassed).

⁴) Weighted network, input level.

FM tuner section

Tuning range

USA and Canadian models:
87.5 MHz – 108.0 MHz (100 kHz step)
Other models:
87.5 MHz – 108.0 MHz (50 kHz step)

Antenna (aerial)

FM wire antenna (aerial)

Antenna (aerial) terminals

75 ohms, unbalanced

Video section

Inputs/Outputs

Video:
1 Vp-p, 75 ohms

HDMI Video

Resolution

- 480p/60 Hz
- 576p/50 Hz
- 720p/60 Hz, 50 Hz, 30 Hz, 24 Hz
- 1080i/60 Hz, 50 Hz
- 1080p/60 Hz, 50 Hz, 30 Hz, 25 Hz, 24 Hz
- 4K/60 Hz*, 50 Hz*, 30 Hz, 25 Hz, 24 Hz

* VIDEO 1 supports YCbCr 4:2:0 8 bit only

Support

HDCP2.2, HDR (HDR10, Hybrid Log-Gamma, Dolby Vision), 3D, Deep Color, ITU-R BT.2020, ARC

For details on supported video formats, visit the Help Guide.

iPhone/iPad/iPod section

BLUETOOTH technology works with iPhone 7 Plus, iPhone 7, iPhone SE, iPhone 6s Plus, iPhone 6s, iPhone 6 Plus, iPhone 6, iPhone 5s, iPhone 5c, iPhone 5, iPhone 4s, and iPod touch (5th and 6th generation.)

AirPlay works with iPhone, iPad, and iPod touch with iOS 4.3.3 or later, Mac with OS X Mountain Lion or later, and PC with iTunes 10.2.2 or later.

You can use “SongPal” app with this receiver via BLUETOOTH or network connection.

iPhone/iPad/iPod playback via Ψ (USB) port is not possible.

USB section

Ψ (USB) port:

Type A (For connecting USB flash drive)

Maximum current

1 A

Network section

Ethernet LAN

100BASE-TX

Wireless LAN

Compatible standards:
IEEE 802.11 a/b/g/n

Security:

WPA/WPA2-PSK, WEP

Radio frequency:

2.4 GHz, 5 GHz

BLUETOOTH section

Communication system

BLUETOOTH Specification version 4.1

Output

BLUETOOTH Specification Power Class 1

Maximum communication range

Line of sight approx. 30 m (98.4 feet)¹⁾

Frequency band

2.4 GHz band (2.4000 GHz – 2.4835 GHz)

Modulation method

FHSS (Freq Hopping Spread Spectrum)

Compatible BLUETOOTH profiles²⁾

A2DP 1.2 (Advanced Audio Distribution Profile)

AVRCP 1.5 (Audio Video Remote Control Profile)

Supported Codecs³⁾

SBC⁴⁾, AAC, LDAC

Transmission range (A2DP)

20 Hz – 40,000 Hz (LDAC sampling frequency 96 kHz with 990 kbps transmission)

20 Hz – 20,000 Hz (Sampling frequency 44.1 kHz)

¹⁾ The actual range will vary depending on factors such as obstacles between devices, magnetic fields around a microwave oven, static electricity, cordless phone, reception sensitivity, antenna's performance, operating system, software application, etc.

²⁾ BLUETOOTH standard profiles indicate the purpose of BLUETOOTH communication between devices.

³⁾ Codec: Audio signal compression and conversion format

⁴⁾ Subband Codec

General

Power requirements

Area	Power requirements
USA, Canada	120 V AC, 60 Hz
Oceania	230 V AC, 50 Hz
Europe	230 V AC, 50/60 Hz

Operating frequency and maximum output power (for European models)

Wireless LAN/BLUETOOTH

Operating frequency	Maximum output power
2400 - 2483.5 MHz	≤ 20.0 dBm

Wireless LAN

Operating frequency	Maximum output power
5150 - 5250 MHz	≤ 23.0 dBm
5250 - 5350 MHz	≤ 20.0 dBm
5470 - 5725 MHz	≤ 20.0 dBm
5725 - 5850 MHz	≤ 14.0 dBm

NFC

Operating frequency	Maximum output power
13.56 MHz	< 60 dBμA/m at 10 m

Power consumption

240 W

European models

Standby mode: 0.4 W
(When [Control for HDMI], [Standby Through], [Bluetooth Standby], and all zone power are set to [Off].)

Bluetooth Standby mode: 1.5 W
(When [Bluetooth Standby] is set to [On], and [Control for HDMI], [Standby Through], and all zone power are set to [Off].)

Networked standby (all wired network ports are connected, all wireless network ports are activated): 1.5 W

Other models

Standby mode: 0.4 W
(When [Control for HDMI], [Standby Through], [Remote Start], [Bluetooth Standby], [Network Standby], and all zone power are set to [Off].)

Bluetooth Standby mode: 2.5 W
(When [Bluetooth Standby] is set to [On], and [Control for HDMI], [Standby Through], [Remote Start], [Network

Standby], and all zone power are set to [Off].)

Dimensions (width/height/depth) (Approx.)
430 mm × 156 mm × 331 mm (17 in × 6 1/4 in × 13 1/8 in) including projecting parts and controls

Mass (Approx.)

9.1 kg (20 lb 1 oz) (USA and Canadian models)

9.7 kg (21 lb 6 oz) (European and Oceanian models)

Design and specifications are subject to change without notice.

Playable types of audio files

Codec	Extension
MP3 (MPEG 1 Audio Layer-3) ¹⁾	.mp3
AAC/HE-AAC ^{1), 2)}	.m4a, .aac ³⁾ , .mp4 ³⁾ , .3gp ³⁾
WMA9 Standard ²⁾	.wma
WMA 10 Pro ^{3), 4)}	.wma
LPCM ¹⁾	.wav
FLAC ²⁾	.flac, .fla
Dolby Digital ^{1), 3)}	.ac3
DSF ²⁾	.dsf
DSDIFF ^{2), 5)}	.dff
AIFF ²⁾	.aiff, .aif
ALAC ²⁾	.m4a
Vorbis	.ogg
Monkey's Audio	.ape

¹⁾ The receiver can play ".mka" files. These files cannot be played on a home network server.

²⁾ The receiver may not play this file format on a home network server.

³⁾ The receiver does not play this file format on a home network server.

⁴⁾ The receiver does not play Lossless coded files.

⁵⁾ The receiver does not play DST encoded files.

Note

- Some files may not play depending on the file format, the file encoding, the recording condition, or the home network server condition.
- Some files edited on a PC may not play.
- Fast forward or fast reverse may not be available with some files.
- The receiver does not play coded files such as DRM.
- The receiver can recognize the following files or folders in USB devices:
 - up to folders in the 9th layer (including the root folder)
 - up to 500 files/folders in a single layer
- The receiver can recognize the following files or folders stored in the home network server:
 - up to folders in the 19th layer
 - up to 999 files/folders in a single layer
- Some USB devices may not work with this receiver.
- The receiver can recognize Mass Storage Class (MSC) devices (such as flash drive or an HDD) and 101-key keyboards.

Supported digital audio formats

The digital audio formats that this receiver can decode depend on the digital audio output jacks of the connected device. This receiver supports the following audio formats. The words in brackets are those indicated on the display panel.

Digital audio format	Maximum number of decoded channels	Connection with the receiver
Dolby Digital [DOLBY D]	5.1	COAXIAL/OPTICAL, HDMI
Dolby Digital Plus [DOLBY D +] ¹⁾	7.1	HDMI
Dolby TrueHD [DOLBY HD] ¹⁾	7.1	HDMI
Dolby Atmos – Dolby Digital Plus [DAtmos] ^{1), 2)}	5.1.2, 7.1, or 7.1.2 ³⁾	HDMI
Dolby Atmos – Dolby TrueHD [DAtmos] ^{1), 2)}	5.1.2, 7.1, or 7.1.2 ³⁾	HDMI
DTS [DTS]	5.1	COAXIAL/OPTICAL, HDMI
DTS-ES Discrete [DTS-ES Dsc]	6.1	COAXIAL/OPTICAL, HDMI
DTS-ES Matrix [DTS-ES Mtx]	6.1	COAXIAL/OPTICAL, HDMI
DTS 96/24 [DTS 96/24]	5.1	COAXIAL/OPTICAL, HDMI
DTS-HD High Resolution Audio [DTS-HD HR] ¹⁾	7.1	HDMI
DTS-HD Master Audio [DTS-HD MA] ¹⁾	7.1	HDMI
DTS:X [DTS:X] ¹⁾	5.1.2, 7.1, or 7.1.2 ³⁾	HDMI
DTS:X Master Audio [DTS:X MA] ¹⁾	5.1.2, 7.1, or 7.1.2 ³⁾	HDMI
DSD [DSD] ^{1), 4)}	5.1	HDMI
Multi Channel Linear PCM [PCM] ¹⁾	7.1	HDMI

¹⁾ Audio signals are output in another format if the playback device does not correspond to the actual format.

For details, refer to the operating instructions of the playback device.

²⁾ Dolby Atmos is decoded as Dolby Digital Plus or Dolby TrueHD if the speaker pattern is set to 2.0, 2.1, 3.0, 3.1, 4.0, 4.1, 5.0 or 5.1.

³⁾ Available only when [SpeakerRelocation/PhantomSurroundBack] is set to [Type A] or [Type B].

⁴⁾ This format is not output to wireless headphones.

END USER LICENSE AGREEMENT

IMPORTANT:

BEFORE USING THE SOFTWARE, PLEASE READ THIS END USER LICENSE AGREEMENT (“EULA”) CAREFULLY. BY USING THE SOFTWARE YOU ARE ACCEPTING THE TERMS OF THIS EULA. IF YOU DO NOT ACCEPT THE TERMS OF THIS EULA, YOU MAY NOT USE THE SOFTWARE.

This EULA is a legal agreement between you and Sony Corporation (“SONY”). This EULA governs your rights and obligations regarding the SONY software of SONY and/or its third party licensors (including SONY’s affiliates) and their respective affiliates (collectively, the “THIRD-PARTY SUPPLIERS”), together with any updates/upgrades provided by SONY, any printed, on-line or other electronic documentation for such software, and any data files created by operation of such software (collectively, the “SOFTWARE”).

Notwithstanding the foregoing, any software in the SOFTWARE having a separate end user license agreement (including, but not limited to, GNU General Public license and Lesser/Library General Public License) shall be covered by such applicable separate end user license agreement in lieu of the terms of this EULA to the extent required by such separate end user license agreement (“EXCLUDED SOFTWARE”).

SOFTWARE LICENSE

The SOFTWARE is licensed, not sold. The SOFTWARE is protected by copyright and other intellectual property laws and international treaties.

COPYRIGHT

All right and title in and to the SOFTWARE (including, but not limited to, any images, photographs, animation, video, audio, music, text and “applets” incorporated into the SOFTWARE) is owned by SONY or one or more of the THIRD-PARTY SUPPLIERS.

GRANT OF LICENSE

SONY grants you a limited license to use the SOFTWARE solely in connection with your compatible device (“DEVICE”) and only for your individual, non-commercial use. SONY and the THIRD-PARTY SUPPLIERS expressly reserve all rights, title and interest (including, but not limited to, all intellectual property rights) in and to the SOFTWARE that this EULA does not specifically grant to you.

REQUIREMENTS AND LIMITATIONS

You may not copy, publish, adapt, redistribute, attempt to derive source code, modify, reverse engineer, decompile, or disassemble any of the SOFTWARE, whether in whole or in part, or create any derivative works from or of the SOFTWARE unless such derivative works are intentionally facilitated by the SOFTWARE. You may not modify or tamper with any digital rights management functionality of the SOFTWARE. You may not bypass, modify, defeat or circumvent any of the functions or protections of the SOFTWARE or any mechanisms operatively linked to the SOFTWARE. You may not separate any individual component of the SOFTWARE for use on more than one DEVICE unless expressly authorized to do so by SONY. You may not remove, alter, cover or deface any trademarks or notices on the SOFTWARE. You may not share, distribute, rent, lease, sublicense, assign, transfer or sell the SOFTWARE. The software, network services or other products other than SOFTWARE upon which the SOFTWARE’S performance depends might be interrupted or discontinued at the discretion of the suppliers (software suppliers, service suppliers, or SONY). SONY and such suppliers do not warrant that the SOFTWARE, network services, contents or other products will continue to be available, or will operate without interruption or modification.

USE OF SOFTWARE WITH COPYRIGHTED MATERIALS

The SOFTWARE may be capable of being used by you to view, store, process and/or use content created by you and/or third parties. Such content may be protected by copyright, other intellectual property laws, and/or agreements. You agree to use the SOFTWARE only in compliance with all such laws and agreements that apply to such content. You acknowledge and agree that SONY may take appropriate measures to protect the copyright of content stored, processed or used by the SOFTWARE. Such measures include, but are not limited to, counting the frequency of your backup and restoration through certain SOFTWARE features, refusal to accept your request to enable restoration of data, and termination of this EULA in the event of your illegitimate use of the SOFTWARE.

CONTENT SERVICE

PLEASE ALSO NOTE THAT THE SOFTWARE MAY BE DESIGNED TO BE USED WITH CONTENT AVAILABLE THROUGH ONE OR MORE CONTENT SERVICES ("CONTENT SERVICE"). USE OF THE SERVICE AND THAT CONTENT IS SUBJECT TO THE TERMS OF SERVICE OF THAT CONTENT SERVICE. IF YOU DECLINE TO ACCEPT THOSE TERMS, YOUR USE OF THE SOFTWARE WILL BE LIMITED. You acknowledge and agree that certain content and services available through the SOFTWARE may be provided by third parties over which SONY has no control. USE OF THE CONTENT SERVICE REQUIRES AN INTERNET CONNECTION. THE CONTENT SERVICE MAY BE DISCONTINUED AT ANY TIME.

INTERNET CONNECTIVITY AND THIRD PARTY SERVICES

You acknowledge and agree that access to certain SOFTWARE features may require an Internet connection for which you are solely responsible. Further, you are solely responsible for payment of any third party fees associated with your Internet connection, including but not limited to Internet service provider or airtime charges. Operation of the SOFTWARE may be limited or restricted depending on the capabilities, bandwidth or technical limitations of your Internet connection and service. The provision, quality and security of such Internet connectivity are the sole responsibility of the third party providing such service.

EXPORT AND OTHER REGULATIONS

You agree to comply with all applicable export and re-export restrictions and regulations of the area or country in which you reside, and not to transfer, or authorize the transfer, of the SOFTWARE to a prohibited country or otherwise in violation of any such restrictions or regulations.

HIGH RISK ACTIVITIES

The SOFTWARE is not fault-tolerant and is not designed, manufactured or intended for use or resale as on-line control equipment in hazardous environments requiring fail-safe performance, such as in the operation of nuclear facilities, aircraft navigation or communication systems, air traffic control, direct life support machines, or weapons systems, in which the failure of the SOFTWARE could lead to death, personal injury, or severe physical or environmental damage ("HIGH RISK ACTIVITIES"). SONY, each of the THIRD-PARTY SUPPLIERS, and each of their respective affiliates specifically disclaim any express or implied warranty, duty or condition of fitness for HIGH RISK ACTIVITIES.

EXCLUSION OF WARRANTY ON SOFTWARE

You acknowledge and agree that use of the SOFTWARE is at your sole risk and that you are responsible for use of the SOFTWARE. The SOFTWARE is provided "AS IS," without warranty, duty or condition of any kind.

SONY AND EACH OF THE THIRD-PARTY SUPPLIERS (for purposes of this Section, SONY and each of the THIRD-PARTY SUPPLIERS shall be collectively referred to as "SONY") EXPRESSLY DISCLAIM ALL WARRANTIES, DUTIES OR CONDITIONS, EXPRESS OR IMPLIED, INCLUDING, BUT NOT LIMITED TO, THE IMPLIED WARRANTIES OF MERCHANTABILITY, NONINFRINGEMENT AND FITNESS FOR A PARTICULAR PURPOSE. SONY DOES NOT WARRANT OR MAKE ANY CONDITIONS OR REPRESENTATIONS (A) THAT THE FUNCTIONS CONTAINED IN ANY OF THE SOFTWARE WILL MEET YOUR REQUIREMENTS OR THAT THEY WILL BE UPDATED, (B) THAT THE OPERATION OF ANY OF THE SOFTWARE WILL BE CORRECT OR ERROR-FREE OR THAT ANY DEFECTS WILL BE CORRECTED, (C) THAT THE SOFTWARE WILL NOT DAMAGE ANY OTHER SOFTWARE, HARDWARE OR DATA, (D) THAT ANY SOFTWARE, NETWORK SERVICES (INCLUDING THE INTERNET) OR PRODUCTS (OTHER THAN THE SOFTWARE) UPON WHICH THE SOFTWARE'S PERFORMANCE DEPENDS WILL CONTINUE TO BE AVAILABLE, UNINTERRUPTED OR UNMODIFIED, AND (E) REGARDING THE USE OR THE RESULTS OF THE USE OF THE SOFTWARE IN TERMS OF ITS CORRECTNESS, ACCURACY, RELIABILITY, OR OTHERWISE.

NO ORAL OR WRITTEN INFORMATION OR ADVICE GIVEN BY SONY OR AN AUTHORIZED REPRESENTATIVE OF SONY SHALL CREATE A WARRANTY, DUTY OR CONDITION OR IN ANY WAY INCREASE THE SCOPE OF THIS WARRANTY. SHOULD THE SOFTWARE PROVE DEFECTIVE YOU ASSUME THE ENTIRE COST OF ALL NECESSARY SERVICING, REPAIR OR CORRECTION. SOME JURISDICTIONS DO NOT ALLOW THE EXCLUSION OF IMPLIED WARRANTIES, SO THESE EXCLUSIONS MAY NOT APPLY TO YOU.

LIMITATION OF LIABILITY

SONY AND EACH OF THE THIRD-PARTY SUPPLIERS (for purposes of this Section, SONY and each of the THIRD-PARTY SUPPLIERS shall be collectively referred to as "SONY") SHALL NOT BE LIABLE FOR ANY INCIDENTAL OR CONSEQUENTIAL DAMAGES FOR BREACH OF ANY EXPRESS OR IMPLIED WARRANTY, BREACH OF CONTRACT, NEGLIGENCE, STRICT LIABILITY OR UNDER ANY OTHER LEGAL THEORY RELATED TO THE SOFTWARE, INCLUDING, BUT NOT LIMITED TO, ANY DAMAGES ARISING OUT OF LOSS OF PROFITS, LOSS OF REVENUE, LOSS OF DATA, LOSS OF USE OF THE SOFTWARE OR ANY ASSOCIATED HARDWARE, DOWN TIME AND USER'S TIME, EVEN IF ANY OF THEM HAVE BEEN ADVISED OF THE POSSIBILITY OF SUCH DAMAGES. IN ANY CASE, EACH AND ALL OF THEIR AGGREGATE LIABILITY UNDER ANY PROVISION OF THIS EULA SHALL BE LIMITED TO THE AMOUNT ACTUALLY PAID FOR THE PRODUCT. SOME JURISDICTIONS DO NOT ALLOW THE EXCLUSION OR LIMITATION OF INCIDENTAL OR CONSEQUENTIAL DAMAGES, SO THE ABOVE EXCLUSION OR LIMITATION MAY NOT APPLY TO YOU.

AUTOMATIC UPDATE FEATURE

From time to time, SONY or the THIRD-PARTY SUPPLIERS may automatically update or otherwise modify the SOFTWARE, including, but not limited to, for purposes of enhancement of security functions, error correction and improvement of functions, at such time as you interact with SONY's or third parties' servers, or otherwise. Such updates or modifications may delete or change the nature of features or other aspects of the SOFTWARE, including, but not limited to, functions you may rely upon. You acknowledge and agree that such activities may occur at SONY's sole discretion and that SONY may condition continued use of the SOFTWARE upon your complete installation or acceptance of such update or modifications. Any updates/modifications shall be deemed to be, and shall constitute part of, the SOFTWARE for purposes of this EULA. By acceptance of this EULA, you consent to such update/modification.

ENTIRE AGREEMENT, WAIVER, SEVERABILITY

This EULA and SONY's privacy policy, each as amended and modified from time to time, together constitute the entire agreement between you and SONY with respect to the SOFTWARE. The failure of SONY to exercise or enforce any right or provision of this EULA shall not constitute a waiver of such right or provision. If any part of this EULA is held invalid, illegal, or unenforceable, that provision shall be enforced to the maximum extent permissible so as to maintain the intent of this EULA, and the other parts will remain in full force and effect.

GOVERNING LAW AND JURISDICTION

The United Nations Convention on Contracts for the International Sale of Goods shall not apply to this EULA. This EULA shall be governed by the laws of Japan, without regards to conflict of laws provisions. Any dispute arising out of this EULA shall be subject to the exclusive venue of the Tokyo District Court in Japan, and the parties hereby consent to the venue and jurisdiction of such courts.

EQUITABLE REMEDIES

Notwithstanding anything contained in this EULA to the contrary, you acknowledge and agree that any violation of or non-compliance with this EULA by you will cause irreparable harm to SONY, for which monetary damages would be inadequate, and you consent to SONY obtaining any injunctive or equitable relief that SONY deems necessary or appropriate in such circumstances. SONY may also take any legal and technical remedies to prevent violation of and/or to enforce this EULA, including, but not limited to, immediate termination of your use of the SOFTWARE, if SONY believes in its sole discretion that you are violating or intend to violate this EULA. These remedies are in addition to any other remedies SONY may have at law, in equity or under contract.

TERMINATION

Without prejudice to any of its other rights, SONY may terminate this EULA if you fail to comply with any of its terms. In case of such termination, you must cease all use, and destroy any copies, of the SOFTWARE.

AMENDMENT

SONY RESERVES THE RIGHT TO AMEND ANY OF THE TERMS OF THIS EULA AT ITS SOLE DISCRETION BY POSTING NOTICE ON A SONY DESIGNATED WEB SITE, BY EMAIL NOTIFICATION TO AN EMAIL ADDRESS PROVIDED BY YOU, BY PROVIDING NOTICE AS PART OF THE PROCESS IN WHICH YOU OBTAIN UPGRADES/UPDATES OR BY ANY OTHER LEGALLY RECOGNIZABLE FORM OF NOTICE. If you do not agree to the amendment, you should promptly contact SONY for instructions. Your continued use of the SOFTWARE after the effective date of any such notice shall be deemed your agreement to be bound by such amendment.

THIRD-PARTY BENEFICIARIES

Each THIRD-PARTY SUPPLIER is an express intended third-party beneficiary of, and shall have the right to enforce, each provision of this EULA with respect to the SOFTWARE of such party.

Should you have any questions concerning this EULA, you may contact SONY by writing to SONY at applicable contact address of each area or country.

Copyright © 2014 Sony Corporation.

 **DOLBY ATMOS**®

dts ™

Made for
 iPod  iPhone  iPad

AirPlay

LDAC

HDMI

™ **dlna**
CERTIFIED™

™

<http://www.sony.net/>

* 4 6 8 6 5 2 4 1 4 * (1)